

Odd viscoelasticity

Piotr Surówka

Dutch Institute for Emergent Phenomena (DIEP), University of Amsterdam &
Wrocław University of Science and Technology

Motivation- neutron stars

A neutron star is the collapsed core of a massive supergiant star, which had a total mass of between 10 and 25 solar masses, possibly more if the star was especially metal-rich. Except for black holes neutron stars are the smallest and densest currently known class of stellar objects.

Constructing models of neutron stars requires knowledge of the physics of matter with a density significantly exceeding the density of atomic nuclei.



Elastic crust

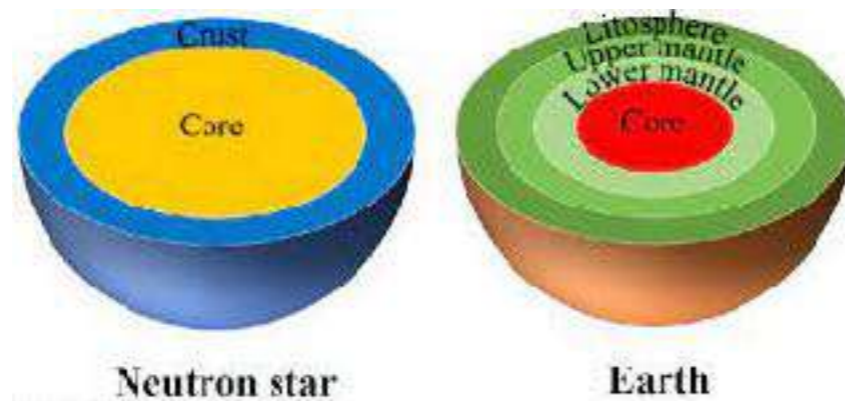

Fluid core

[Wikipedia](#)

Simulated view of a Neutron star with accretion disk. The disk appears distorted near the star due to extreme gravitational lensing

[Gilberti et al.](#)

Motivation- fractional QHE

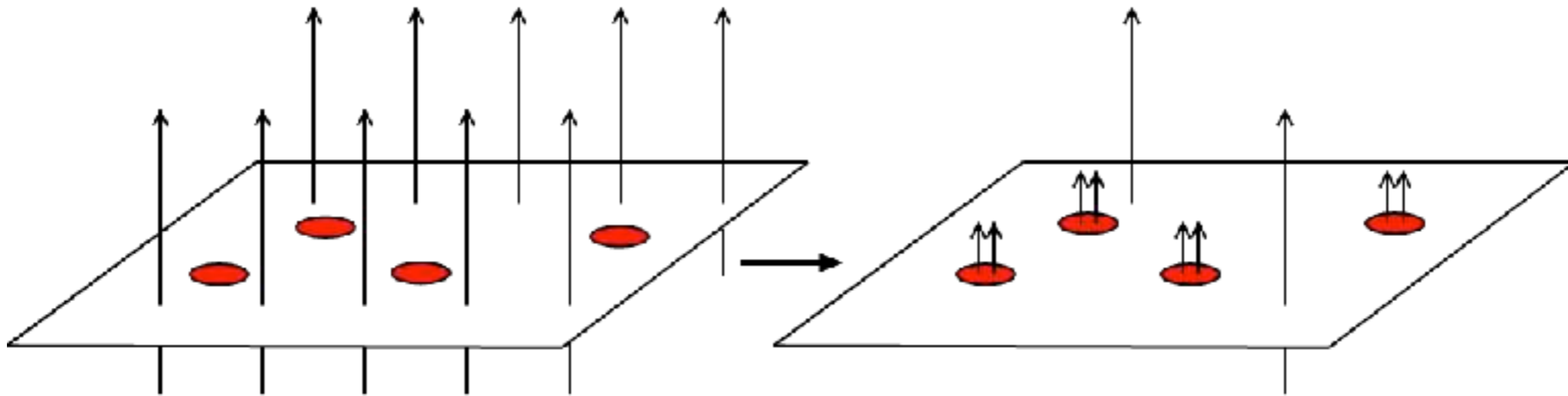

Fractional quantum Hall fluids, where the lowest gapped mode is a spin-two mode, the so-called magneton.

Haldane proposed that the theory governing the dynamics of the magneton at long wavelength is a theory of a dynamical metric.

One of the key features of incompressible FQH liquids is a highly collective response to external perturbations. In this respect FQH liquids look similar to the “classical” liquids and solids. Hydrodynamic theory of fractional quantum Hall states is viscoelastic as suggested by Tokatly and later revisited by Son.

Motivation- composite materials

Concrete is cheap and relatively light, but it breaks apart easily under tension. By contrast, steel is strong but expensive and heavy. By pouring the concrete around prestressed metal bars one obtains a composite, namely, reinforced concrete, that is cheap, relatively light, and strong.

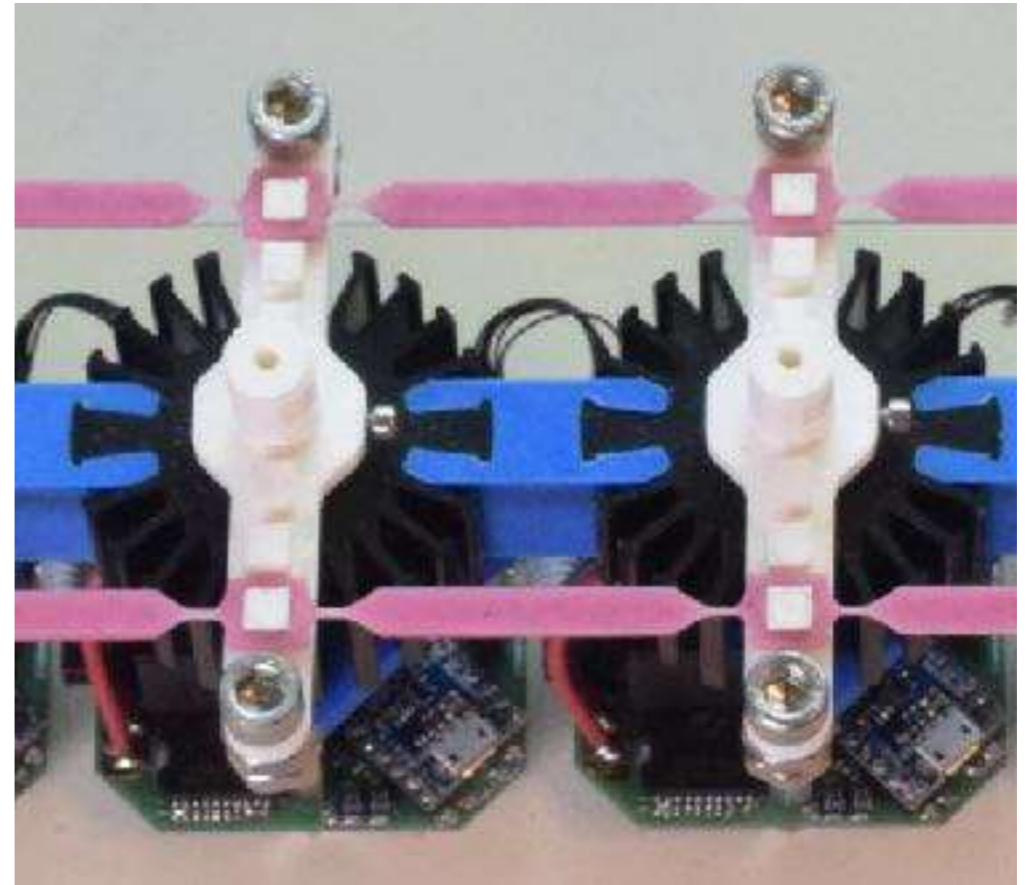

Coulais Lab

Modern day composites can also involve materials made of programmable robots. Macroscopic description of such materials requires a modified viscoelastic description.

Active matter



Hans Overduin/NIS/Minden/Getty



SardiTemp

We want to understand the principles behind systems, whose microscopic constituents are not in equilibrium (flocks, fish schools)

Active matter systems are made up of units that consume energy. Physicists group flocks of birds, molecular motors and layers of vibrating grains together in this category because they all extract energy from their surroundings at a single particle level and transform it into mechanical work. By studying the behaviors that emerge, our understanding of these systems can be enhanced and new frameworks for investigating the statistical physics of out-of-equilibrium systems can be built.

Active matter

Although understanding active matter is in general challenging due to its overall complexity, we want to have some basic organising principles based on symmetries and conservation laws. This is in analogy to what we do in physics to construct the long-wavelength hydrodynamic behaviour of microscopic systems.

- Dry active matter
- Wet active matter

This classification is based on the momentum conservation. Dry systems do not conserve momentum and wet systems conserve momentum. Examples of dry active matter include migrating animals and wet active matter e.g. various suspensions.

Here we are interested in understanding models and principles behind activity in the context of viscoelasticity. Most of the work in this direction is concerned with systems containing polar order. As we will see odd viscoelasticity is different and offers a much simpler framework.

Landau paradigm

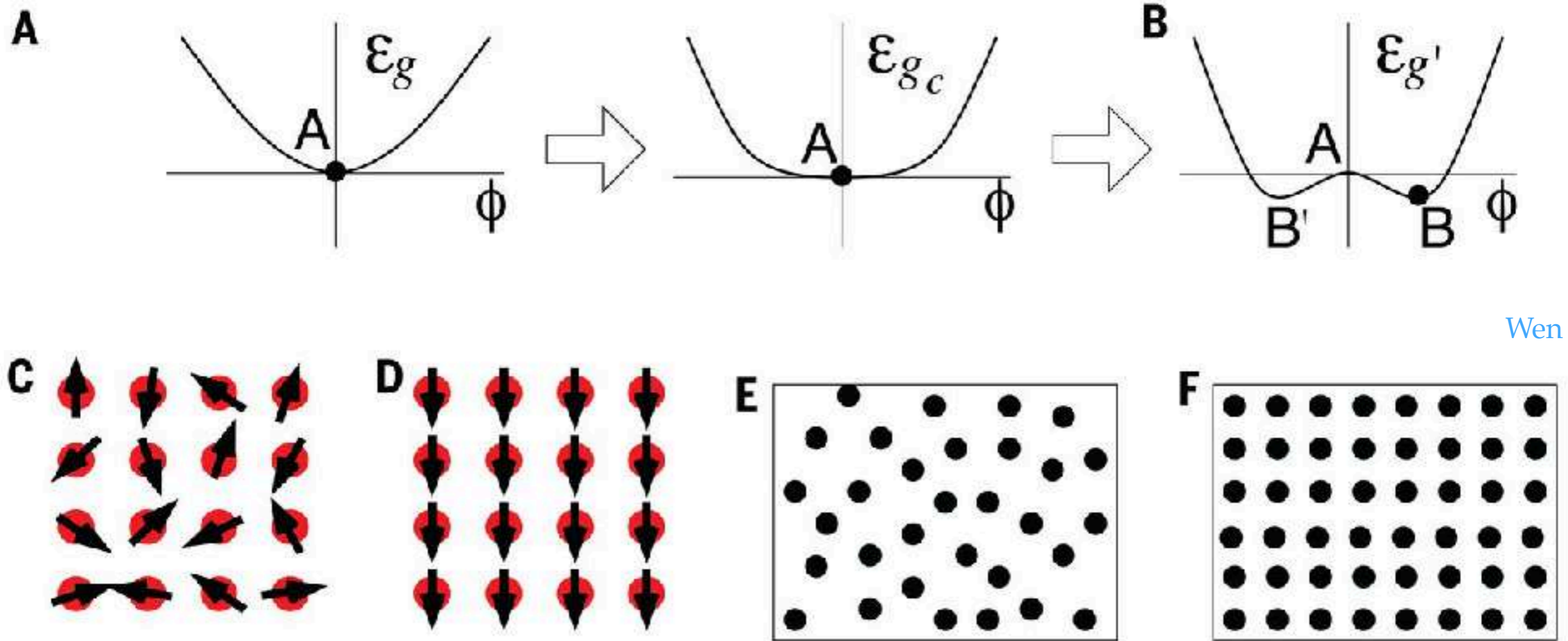

Disordered liquid states that do not break any symmetry [(A), (C), and (E)].
Ordered states that spontaneously break some symmetries [(B), (D), and (F)].
For example, the energy function has a symmetry $\phi \rightarrow -\phi$, $\epsilon_g(\phi) = \epsilon_g(-\phi)$.
However, as the parameter g (e.g., magnetic field) changes, the minimal energy state (the ground state) sometimes respects the symmetry [(A), (C), and (E)] and other times must settle into a state that does not respect the symmetry.
Landau theory generalizes the above picture to describe all phases and all phase transitions. Within this theory, the symmetry of the ordering of constituent particles distinguishes one phase from another.

Elasticity

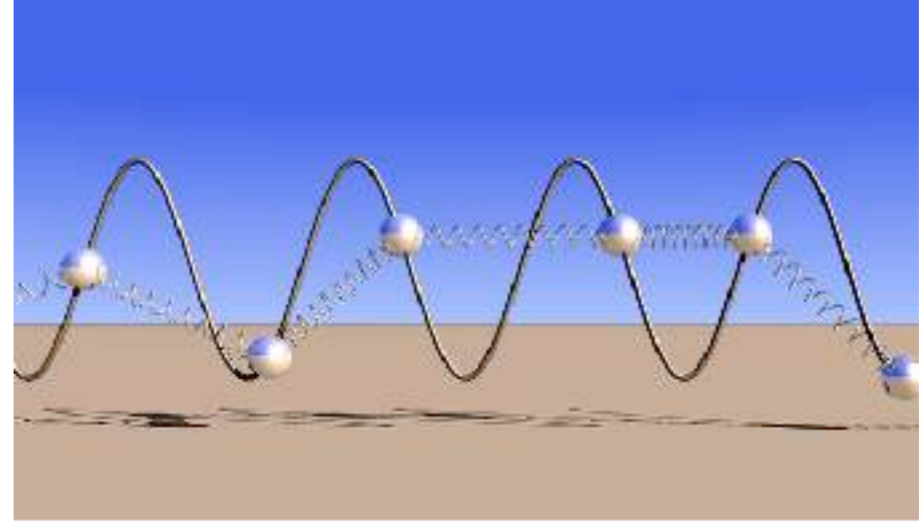

Wikipedia

At distances large compared to the lattice constant, one can define a displacement field

$$\vec{u}(\vec{x}, t)$$

such that

$$\vec{x}'(t) = \vec{x}(t) + \vec{u}(\vec{x}, t)$$

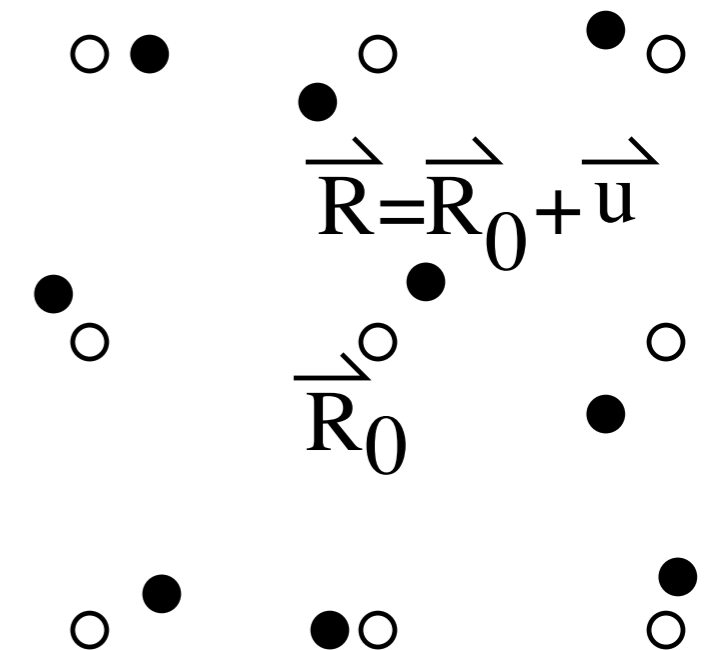

The distance vector between two material points at \vec{x} and \vec{y} is changed from $d\vec{x} = \vec{x} - \vec{y}$ to $dx'_a = dx_a + \partial_b u^a dx_b$, and its length from $dr = \sqrt{d\vec{x}^2}$ to $dr' = \sqrt{d\vec{x}^2 + 2u_{ab}dx_a dx_b}$ where the strain tensor u_{ab} is in linear approximation,

$$u_{ab} = \frac{1}{2} (\partial_b u^a + \partial_a u^b).$$

Cosserat elasticity

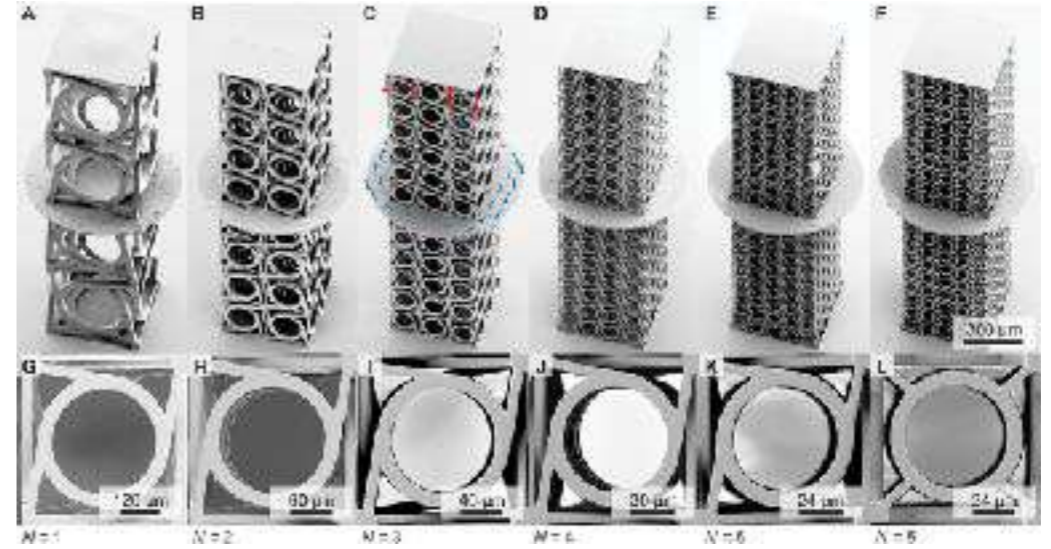

Frenzel
et al.

The Cosserat theory of elasticity, also known as micropolar elasticity, endows classical elasticity with local rotations. Physically it means that the elastic body is not considered as a collection of points at the microscopic level but rather of extended objects that can rotate in space. In two dimensions the displacement vector u_i is supplemented with an orientation angle θ . In the second step we require that the effective action/free energy is invariant under translations and rotations. Translations require that under the transformation $u_i \rightarrow u_i + b_i$, where b_i is a constant vector the action remains invariant. Rotations by a constant angle θ_0 are implemented by two simultaneous transformations $\theta \rightarrow \theta + \theta_0$, $u_i \rightarrow u_i + \epsilon_{ij}x_j\theta_0$. Gradients of the displacement field are invariant under translations but not under rotations. It is, however, possible to construct a combination

$$\gamma_{ij} = \partial_i u_j - \epsilon_{ij} \theta$$

The free energy reads

$$F = \int dt d^2x \left[\dot{\theta} \dot{\theta} + \dot{u}^i \dot{u}^i - C^{ijkl} \gamma_{ij} \gamma_{kl} + \zeta \tau_i \tau^i \right]$$

Active diffusion

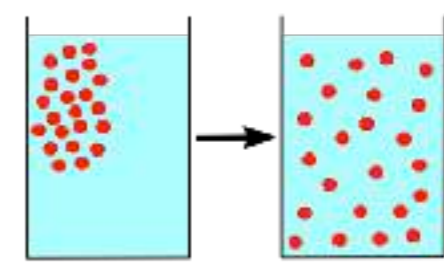

Wikipedia

We are interested in a long-wavelength / long time dynamics of active systems. Let us look at a simple example of diffusion

$$\partial_t \rho(t, x) = \nabla_i J^i(t, x)$$

Our hydrodynamic theory is a theory of a single scalar quantity - density. Interactions with the bath are measured by a chemical potential. In order to make the approach useful we express the current as an expansion around equilibrium.

$$\rho(t, x) = C_1 \mu(t, x) + \mathcal{O}(\nabla^2) \quad J_i(t, x) = D_1 \nabla_i \mu(t, x) + \mathcal{O}(\nabla^2)$$

We are interested in a long-wavelength / long time dynamics of active systems. Let us look at a simple example of diffusion

$$\partial_t \rho(t, x) = \frac{D_1}{C_1} \nabla_i \nabla^i \rho(t, x) \equiv D \nabla_i \nabla^i \rho(t, x)$$

In equilibrium constrains on the coefficients and terms than can appear. In active systems no such constraints. General lesson for active systems - transport coefficients can have values forbidden in equilibrium and new terms can appear.

Hydrodynamics - a theory of conserved quantities

This conservation of particle number is expressed in hydrodynamics as conservation of mass, by the continuity equation

$$\partial_t \rho + \partial_i (\rho u_i) = 0$$

Another equation is the equation of motion of a fluid element. This equation can be written as a momentum conservation equation.

$$\partial_t (\rho u_i) + \partial_j T_{ij} = 0 \qquad T_{ij} = p \delta_{ij} + \rho u_i u_j$$

We are still one equation short to have a complete system. We add entropy conservation equation, which can be expressed as energy conservation using thermodynamics

$$\partial_t \left(\varepsilon + \frac{\rho u^2}{2} \right) + \partial_i \left[\left(w + \frac{\rho u^2}{2} \right) u_i \right]$$

Rewriting we get the Euler's equation

$$\rho \frac{\partial \vec{u}}{\partial t} + \rho \vec{u} \cdot \nabla \vec{u} = -\nabla p$$

Viscoelasticity

Viscoelasticity is the property of materials that exhibit both viscous and elastic characteristics when undergoing deformation.

The creep-recovery test involves loading a material at constant stress, holding that stress for some length of time and then removing the load.

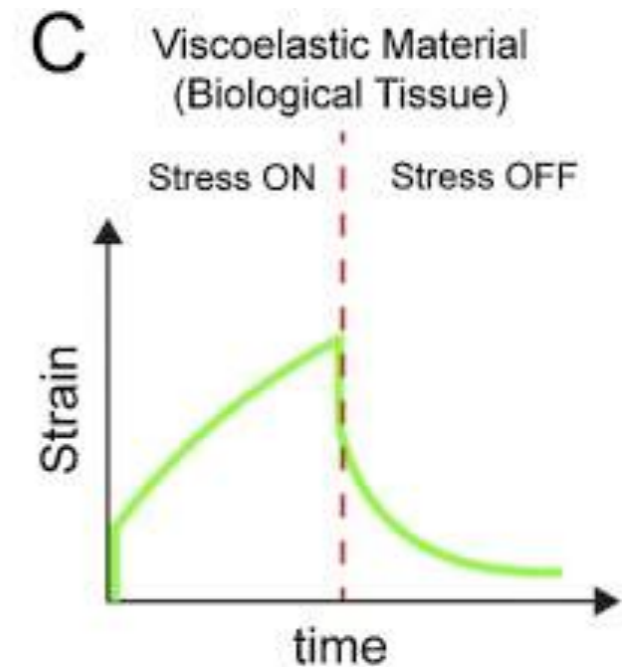
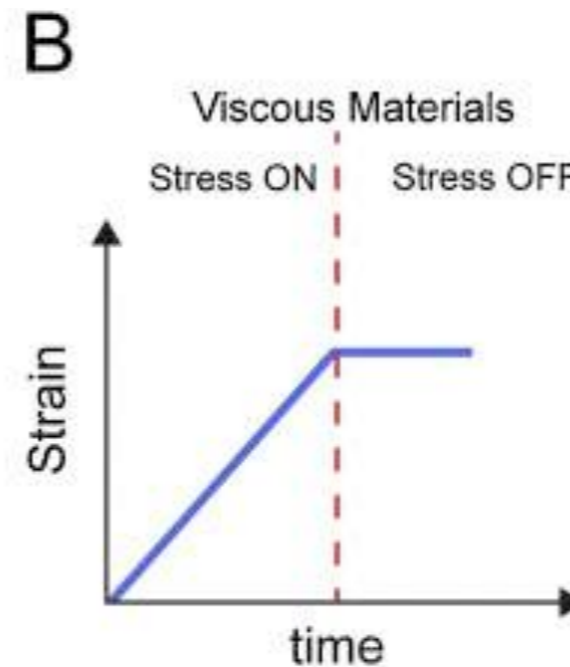
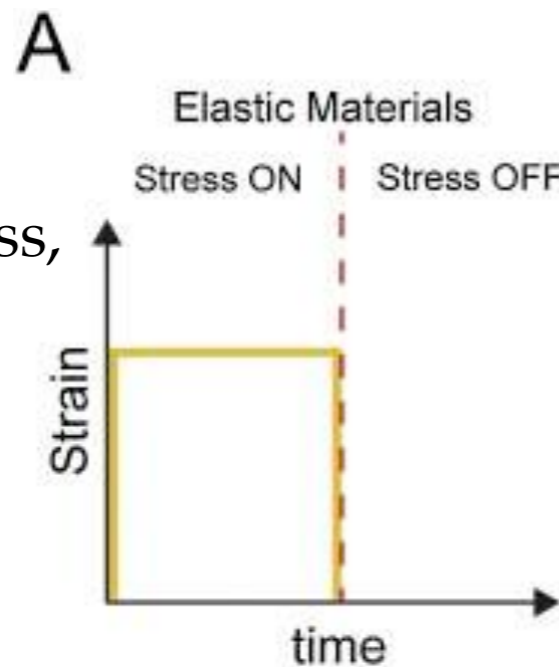

Modelled
by a
spring



Modelled
by a
dashpot/
damper



Modelled by a
combination of
springs and
dashpots

Linear spring

The constitutive equation for a material which responds as a linear elastic spring of stiffness E is

$$\varepsilon = \frac{1}{E} \sigma$$

An elastic material undergoes an instantaneous elastic strain upon loading, maintains that strain so long as the load is applied, and instantaneously goes back to the initial position upon removal of the load.

Linear viscous dashpot

A dashpot responds with a strain rate proportional to the applied stress

$$\dot{\varepsilon} = \frac{1}{\eta} \sigma$$

η is the viscosity of the material. This is the characteristic response of Newtonian fluids. The larger is the stress, the faster is the straining.

Creep recovery response

The creep response follows immediately from the solution of constitutive equations

Dashpot

$$\varepsilon(t) = \sigma_0 J(t) \qquad J(t) = \frac{t}{\eta}$$

$J(t)$ is called the creep (compliance) function.

Linear spring

$$J(t) = \frac{1}{E}$$

Kelvin Voigt solid

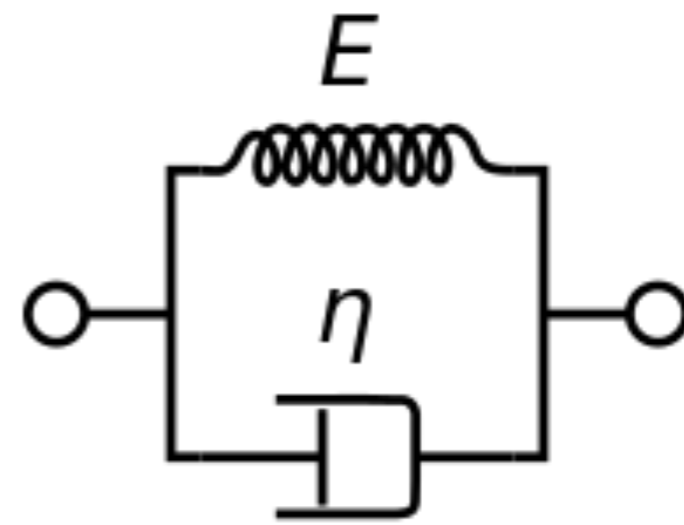

We first consider a two-element model, the Kelvin-Voigt model, which consists of a spring and dashpot in parallel. We assume no bending moment.

$$\varepsilon = \frac{1}{E}\sigma_1 \quad \dot{\varepsilon} = \frac{1}{\eta}\sigma_2 \quad \sigma = \sigma_1 + \sigma_2$$

Total stress is a sum of the individual stresses in the dashpot and the spring. Responses are controlled by elastic and viscous transport coefficients. Eliminating individual components of the stress one gets the constitutive equation:

$$\sigma = E\varepsilon + \eta\dot{\varepsilon}$$

Solving the first order non-homogeneous differential with vanishing initial strain gives

$$\varepsilon(t) = \frac{\sigma_0}{E} \left[1 - e^{-(E/\eta)t} \right] \quad \frac{\eta}{E} \equiv \tau_R$$

Retardation time is a measure of the time taken for the creep strain to accumulate.

Maxwell fluid

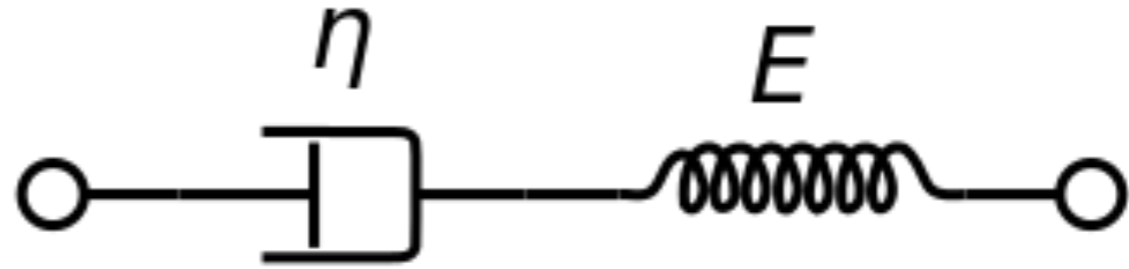

Another possibility for a two element representation of a viscoelasticity is a spring and dashpot in series, known as the Maxwell model.

$$\varepsilon_1 = \frac{1}{E}\sigma \quad \dot{\varepsilon}_2 = \frac{1}{\eta}\sigma \quad \varepsilon = \varepsilon_1 + \varepsilon_2$$

Total strain is a sum of the individual strains in the dashpot and the spring. One can eliminate the individual strains to get the constitutive equation

$$\sigma + \frac{\eta}{E}\dot{\sigma} = \eta\dot{\varepsilon}$$

When the Maxwell model is subjected to a stress, the spring will stretch immediately and the dashpot will take time to react. Using this as the initial condition gives

$$\varepsilon(t) = \sigma_0 \left(\frac{1}{\eta}t + \frac{1}{E} \right)$$

A new feature is the stress relaxation.

Limitations

- The Maxwell model predicts creep, but it does not decrease with time. There is no anelastic recovery (strain recovers over time).
- No stress relaxation in the Kelvin-Voigt model
- Not covariant
- Not applicable to chiral systems
- No plasticity

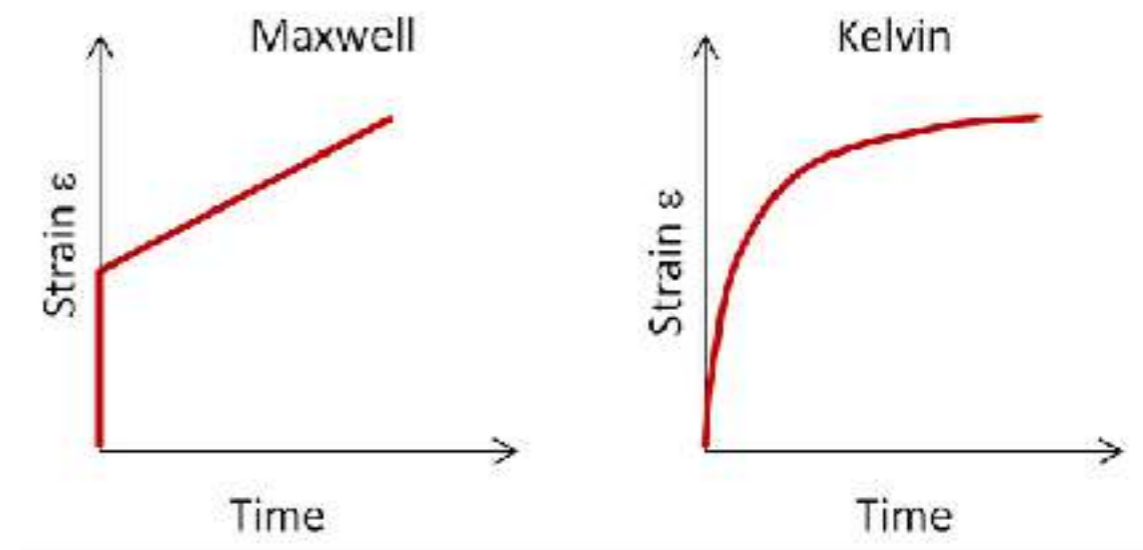

Three element models

The usual procedure to get more realistic models of viscoelasticity is to increase the number of elements. the simplest extension is to add one spring or one dashpot. Again one distinguishes two classes of models: standard linear solids (Zener models) or standard linear fluids (Jeffreys models)

Constitutive relation

$$\sigma + \tau \dot{\sigma} = \mathcal{E}_1 \varepsilon + \tau \mathcal{E}_2 \dot{\varepsilon}$$

$$\sigma + \tau \dot{\sigma} = \eta_1 \dot{\varepsilon} + \tau \eta_2 \ddot{\varepsilon}$$

Representation

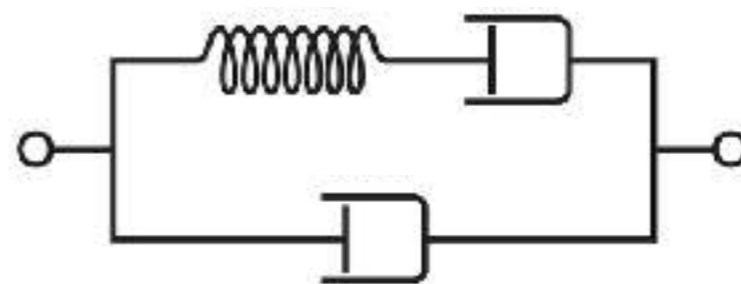
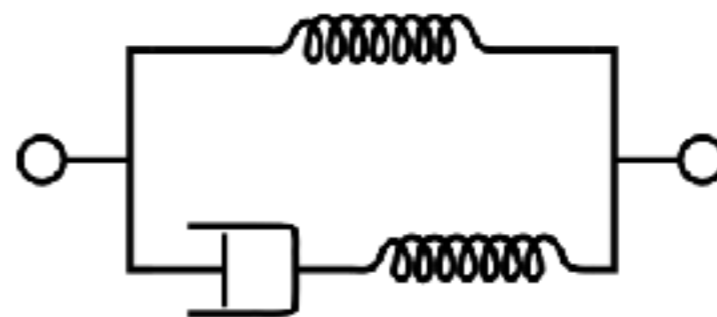

In order to derive the constitutive equations we need to solve equations for individual elements. This can be done in one dimension but becomes not practical in higher dimensions. Therefore we would like to follow the symmetry approach.

Navier-Stokes equation from symmetries

What terms we can write to describe a Galilean invariant fluid? We postulate that in every reference frame the physics is the same

$$t' = t, \quad \vec{x}' = \vec{x} + \vec{u}t, \quad \vec{v}'(t', \vec{x}') = \vec{v}(t, \vec{x}) + \vec{u}$$

We check how the derivatives transform: $\vec{\nabla}' = \vec{\nabla}$ $\nabla'^2 \vec{v}' = \nabla^2 \vec{v}$

$$\frac{\partial}{\partial t'} = \frac{\partial}{\partial t} - \vec{u} \cdot \vec{\nabla} \qquad \frac{\partial \vec{v}'}{\partial t'} = \frac{\partial \vec{v}}{\partial t} - (\vec{u} \cdot \vec{\nabla}) \vec{v}$$

There is a leftover term. We check how it transforms

$$(\vec{v}' \cdot \vec{\nabla}') \vec{v}' = (\vec{v} \cdot \vec{\nabla}) \vec{v} + (\vec{u} \cdot \vec{\nabla}) \vec{v}$$

We can construct an invariant equation

$$\frac{\partial \vec{v}}{\partial t} + (\vec{v} \cdot \vec{\nabla}) \vec{v} = \eta \nabla^2 \vec{v} - \frac{1}{\rho} \vec{\nabla} P$$

Oldroyd models

Oldroyd in 1950 formulated the first systematic attempt to provide constitutive models for viscoelastic fluids in a way that respects material frame indifference. In other words stresses in a continuous medium should arise from deformations only and not from rotations. We saw that in the context of NS equations

$$d/dt \rightarrow \partial/\partial t + (\mathbf{v} \cdot \nabla)$$

This simple substitution does not work if we act on tensors. Oldroyd proposed several derivatives that transform covariantly w.r.t. rotations. In the modern language such a corresponds to a covariance under diffeomorphisms of the fluid manifold. From differential geometry we know that the derivative that generates the diffeomorphism is the Lie derivative.

$$\frac{D}{Dt} A_{j\dots n}^{i\dots m} = \dot{A}_{j\dots n}^{i\dots m} + \mathcal{L}_N A_{j\dots n}^{i\dots m}$$

N^i describes the movement of a fluid particle w.r.t. the coordinate (frame) choice in the fluid space.

Transport and elastic coefficients

A small deformation parametrized by a displacement vector u_i , $i = 1, \dots, d$ produces a stress that depends on the strain $u_{ij} = \partial_i u_j + \partial_j u_i$ and the strain rate $\dot{u}_{ij} \equiv \partial_t u_{ij}$ through the elastic modulus (K) and viscosity (η) tensors

$$T_{ij} = p\delta_{ij} - K_{ijkl}u_{kl} - \eta_{ijkl}\dot{u}_{kl}.$$

As a warm-up exercise let us consider fluids. The first term is the pressure. When time reversal invariance is not broken, the viscosity tensor satisfies Onsager's relations

$$\eta_{ijkl} = \eta_{klij}.$$

For a rotationally invariant system the above relation allows one only two possible transport coefficients, the shear and bulk viscosities

$$\eta_{ijkl} = \eta(\delta_{ik}\delta_{jl} + \delta_{il}\delta_{jk}) + \left(\zeta - \frac{2}{d}\eta\right)\delta^{ij}\delta_{kl}.$$

“Odd” transport in two dim.

When time reversal invariance is broken, as for instance if a background magnetic field is turned on, the conditions Onsager are relaxed and it is possible to have an ‘odd’ contribution to the viscosity

$$\eta_{ijkl}^{(A)} = -\eta_{klij}^{(A)}.$$

A peculiarity of the odd viscosity is that can be dissipationless. The variation of the energy density under a strain is

$$\delta\varepsilon = -T_{ij}\delta u_{ij}.$$

Using the first law of thermodynamics $\delta\varepsilon = T\delta s - p\delta V$, with s the entropy density, T the temperature and V the volume, the change of entropy with time becomes

$$T\dot{s} = \eta_{ijkl}\dot{u}_{ij}\dot{u}_{kl}.$$

Odd viscosity

In general, $\eta^{(A)} = 0$ if rotational invariance is not broken. However, for $d = 2$ spatial dimensions an odd viscosity is allowed if parity is also broken

$$\eta_{ijkl}^{(A)} = -\frac{\eta_H}{2} (\epsilon^{ik} \delta^{jl} + \epsilon^{jk} \delta^{il} + \epsilon^{il} \delta^{jk} + \epsilon^{jl} \delta^{ik}).$$

Shear response

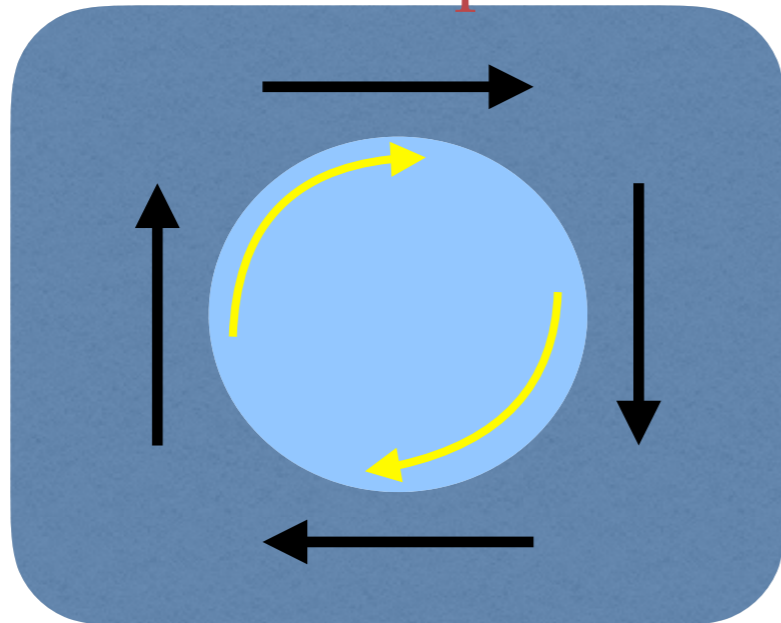

Odd / Hall response

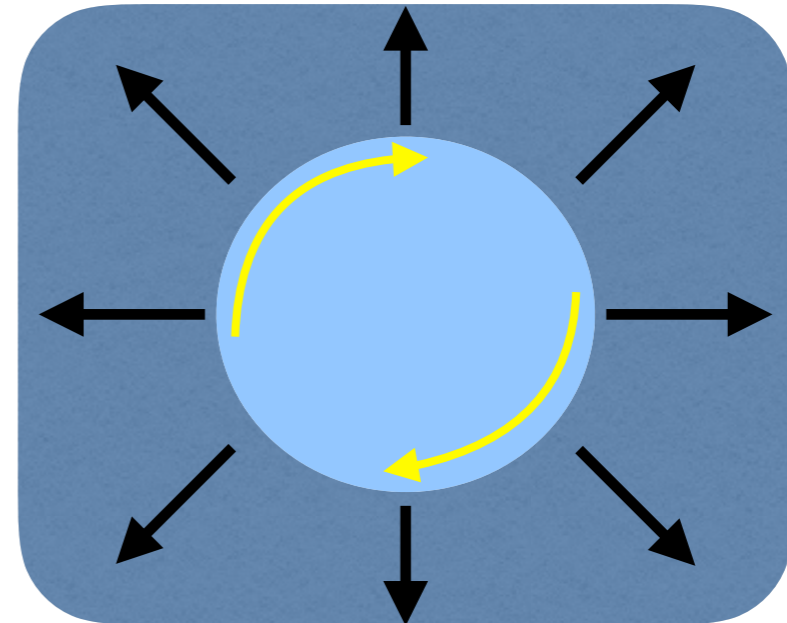

Is it possible to have an analogous expression for elasticity?

“Everyone knew it was impossible, until a fool who didn’t know came along and did it.”— Albert Einstein

Odd viscosity in active matter

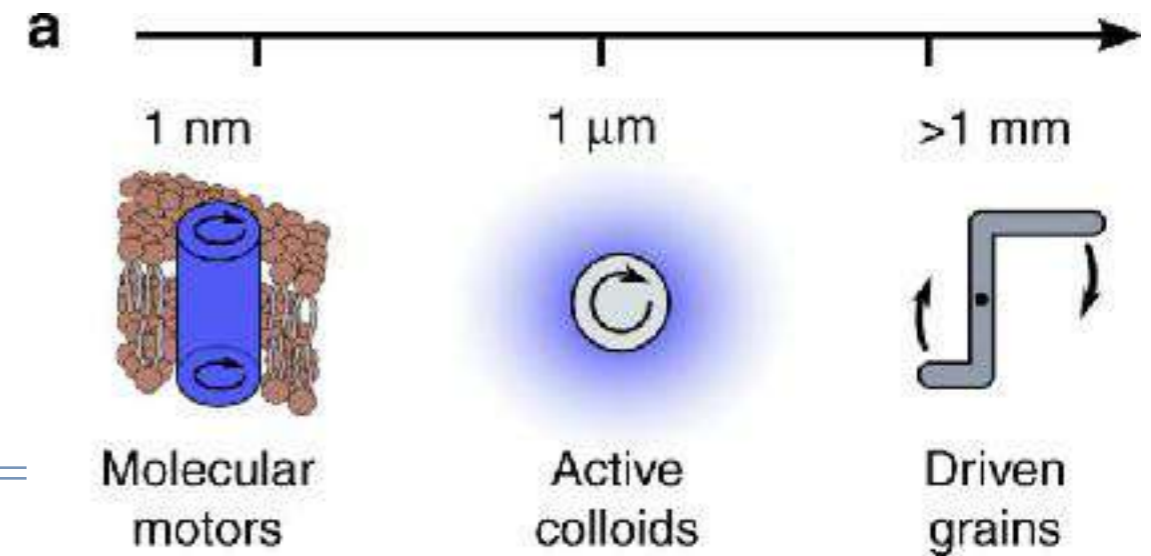

Banerjee, Souslov, Abanov, Vitelli

Conservation of angular momentum dictates that the stress tensor of any medium with vanishing bulk external torque must be symmetric under the exchange of its two indices. This conclusion, however, does not apply to chiral fluids composed of self-spinning constituents.

$$D_t \rho = 0$$

$$D_t \ell = \tau + D^\Omega \nabla^2 \Omega - \Gamma^\Omega \Omega - \epsilon_{ij} \sigma_{ij}$$

$$D_t g_i = \partial_j \sigma_{ij} - \Gamma^v v_i .$$

Angular momentum

$$\ell = I \Omega$$

Linear momentum

$$g_i = \rho v_i$$

Material derivative

$$D_t = \partial_t + v^k \partial_k$$

The idea is to generate odd viscosity as an expansion around non-equilibrium state

$$\sigma_{ij} \equiv \epsilon_{ij} \frac{\Gamma}{2} (\Omega - \omega) - p \delta_{ij} + \eta_{ijkl} v_{kl} + \frac{\ell}{2} (\partial_i v_j^* + \partial_i^* v_j)$$

Odd Elasticity

Free energy for elasticity reads

$$F = \frac{1}{2} \int dt d^2x \left[\dot{u}^i \dot{u}^i - K^{ijkl} u_{ij} u_{kl} \right]$$

Odd terms vanish identically

$$K^{[ij]kl} = 0 \quad \text{left minor symmetry}$$

$$K^{ij[kl]} = 0 \quad \text{right minor symmetry}$$

$$K^{ijkl} = K^{klij} \quad \text{major symmetry}$$

Odd elasticity implies a violation of major symmetries. Differs from Cosserat elasticity.

Elasticity in two dimensions

$$u^0(\mathbf{x}) = \tau_{ij}^0 u_{ij}(\mathbf{x}) \quad \text{Dilation}$$

$$u^1(\mathbf{x}) = \tau_{ij}^1 u_{ij}(\mathbf{x}) \quad \text{Rotation}$$

$$u^2(\mathbf{x}) = \tau_{ij}^2 u_{ij}(\mathbf{x}) \quad \text{Shear strain 1}$$

$$u^3(\mathbf{x}) = \tau_{ij}^3 u_{ij}(\mathbf{x}) \quad \text{Shear strain 2}$$

Avron

$$\begin{pmatrix} \sigma^0(\mathbf{x}) \\ \sigma^1(\mathbf{x}) \\ \sigma^2(\mathbf{x}) \\ \sigma^3(\mathbf{x}) \end{pmatrix} = 2 \begin{pmatrix} K^{00} & K^{01} & K^{02} & K^{03} \\ K^{10} & K^{11} & K^{12} & K^{13} \\ K^{20} & K^{21} & K^{22} & K^{23} \\ K^{30} & K^{31} & K^{32} & K^{33} \end{pmatrix} \begin{pmatrix} u^0(\mathbf{x}) \\ u^1(\mathbf{x}) \\ u^2(\mathbf{x}) \\ u^3(\mathbf{x}) \end{pmatrix}.$$

Viscoelastic odd KV solids

Scheibner, Souslov, Banerjee,
Surówka, Irvine, Vitelli

Isotropy and conservation laws fix the form of the elastic tensor. In the usual case two positive elastic moduli.

$$K^{\alpha\beta} = 2 \begin{pmatrix} \lambda + \mu & 0 & 0 & 0 \\ 0 & 0 & 0 & 0 \\ 0 & 0 & \mu & 0 \\ 0 & 0 & 0 & \mu \end{pmatrix}^{\alpha\beta}$$

If one doesn't impose the conservation of energy two new coefficients are allowed. Stability requires adding a relaxation mechanism e.g. viscosity.

$$K^{\alpha\beta} = 2 \begin{pmatrix} \lambda + \mu & 0 & 0 & 0 \\ A & 0 & 0 & 0 \\ 0 & 0 & \mu & -\kappa_o \\ 0 & 0 & \kappa_o & \mu \end{pmatrix}^{\alpha\beta}$$

Possible mechanical realisation

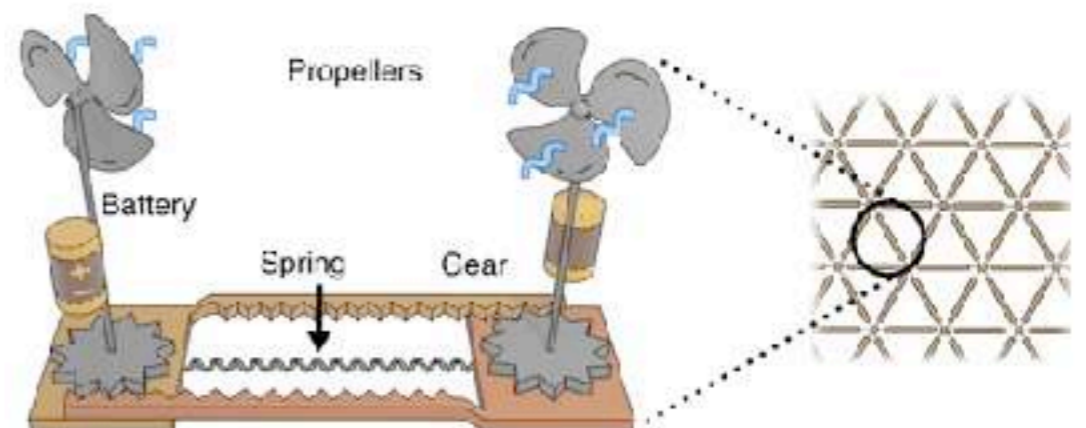

Odd viscoelastic Maxwell fluids

The constitutive equation together with the momentum conservation equation for the Maxwell fluid read

$$v_{kl} = \eta_{ijkl}^{-1} \sigma_{ij} + \kappa_{ijkl}^{-1} \frac{D}{Dt} \sigma_{ij},$$

$$\rho \frac{D}{Dt} v_i = -\partial_i p + \partial_j \sigma_{ij},$$

Banerjee, Vitelli, Jülicher,
Surówka

These equations are much more complicated to deal with than for solids with a lot of unknown properties. As simple physical example we can look at relaxation times

$$\tilde{\tau} = \frac{\eta + \zeta}{\mu + \lambda} \quad \tilde{\tau}_{1,2} = \frac{\eta^o \kappa^o + \eta \mu \pm i(\eta^o \mu - \eta \kappa^o)}{\mu^2 + (\kappa^o)^2}$$

Contrary to even viscoelastic fluids transverse and longitudinal modes cannot be decoupled. The non-dissipative part corresponds to chiral metric hydrodynamics proposed by Son to describe fractional Hall states.

Lift force

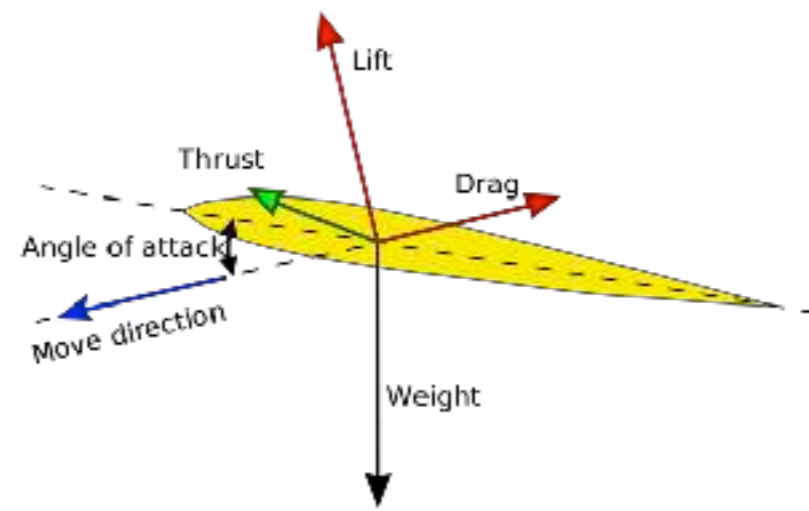

New incarnation of an old problem: what are the forces on a cylinder in an odd fluid?

In a fluid without parity breaking the cylinder experiences only drag. Symmetries in odd fluids do not forbid lift, although it was shown by Ganeshan and Abanov that incompressible odd fluid does not experience lift.

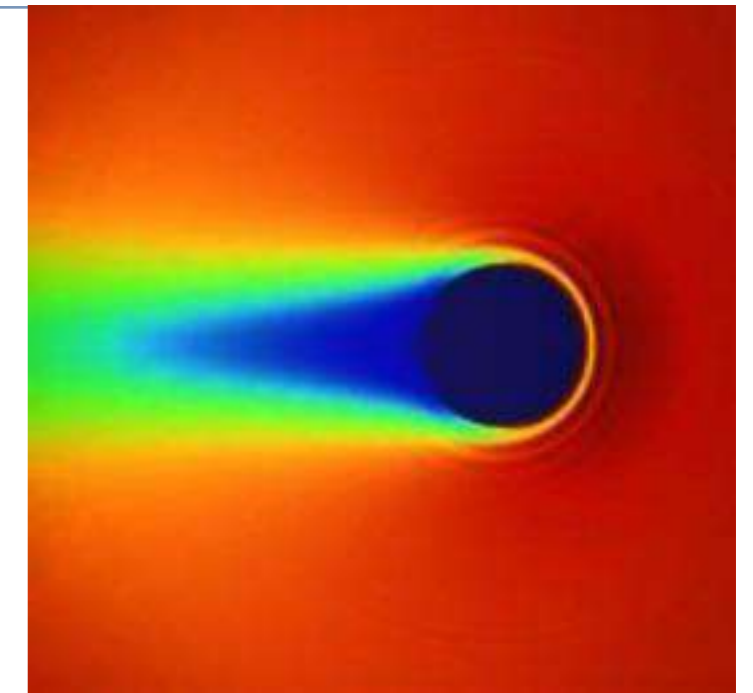

$$f_l \propto \tilde{\omega} \ln \tilde{\omega}$$

Lier, Duclut, Bo, Armas, Jülicher, Surówka, arXiv:2205.12704

What about compressible odd fluids? In the steady case the lift force is present only if mass is not conserved. However, the lift force can be present if the fluid is oscillating. This opens up a possibility to measure it by microrheological experiments.

Conclusions

- Odd viscoelasticity is a new phenomenon, which can shed light on aspects of meta-materials and active matter
- Lift is a potential new experimental probe
- A minimal model to study active turbulence
- Playground for physicists and engineers

Thank you!