

# QCD, Gravity and Inertia

Theoretical Physics Colloquium, College of Integrative  
Sciences and Arts, ASU

July 28, 2021

---

Oleg Teryaev  
Joint Institute for  
Nuclear Research,  
Dubna, Russia



# Main Topics

---

- **E**quivalence **P**inciple: way to merge strongest and weakest interactions
- Gravitational Formfactors: **EP** for spin and its **E**xtension
  - D-term, pressure and inflation
  - Spin-1 and average shear
- Heavy ion collisions : highest vorticity and acceleration
  - Anomalous current and polarization (EFT/TD/Gravity)
  - Unruh radiation



# Strong interactions and gravity

- $E_{EM}/E_G \sim e^2/(m/M_{Pl})^2$        $M_{Pl} \sim 10^{18}$  GeV
- For 2 particles with  $M_{Pl}$  mass at Compton wavelength distance ( $1/M_{Pl}$ ):  
 $E_G \sim (G = 1/M_{Pl}^2) M_{Pl}^2 / (1/M_{Pl}) = M_{Pl}$   
 $g \sim (G = 1/M_{Pl}^2) M_{Pl} / (1/M_{Pl})^2 = M_{Pl}$
- Gravitational interaction is strongly suppressed  $\sim (\Lambda/M_{Pl})^2$
- **Equivalence Principle**
- **I: Acceleration  $\leftrightarrow$  Gravity**
- **HIC:  $a \sim \Lambda$ ,  $a/g \sim \frac{c^2}{v_{\oplus}^2} \cdot \frac{R_{\oplus}}{R_A} \sim 10^{30}$**
- **$M_{Pl} \rightarrow \Lambda$  ("GeV Gravity")**
- **II: Coupling to Energy-Momentum Tensor**

# Electromagnetism vs Gravity (OT'99)

- Interaction – field vs metric deviation

$$M = \langle P' | J_q^\mu | P \rangle A_\mu(q)$$

$$M = \frac{1}{2} \sum_{q,G} \langle P' | T_{q,G}^{\mu\nu} | P \rangle h_{\mu\nu}(q)$$

- Static limit

$$\langle P | J_q^\mu | P \rangle = 2e_q P^\mu$$

$$\sum_{q,G} \langle P | T_i^{\mu\nu} | P \rangle = 2P^\mu P^\nu$$
$$h_{00} = 2\phi(x)$$

$$M_0 = \langle P | J_q^\mu | P \rangle A_\mu = 2e_q M \phi(q)$$

$$M_0 = \frac{1}{2} \sum_{q,G} \langle P | T_i^{\mu\nu} | P \rangle h_{\mu\nu} = 2M \cdot M \phi(q)$$

- Mass as charge – equivalence principle



# EP and hadron structure

---

- “Microscopic” EP (coupling of gravity to EMT)
- +
- Conservation law  
(Momentum SR to get local from LC pdf's):  
 $\int dx x (\Sigma q(x) + G(x))=1$
- =
- “Macroscopic” EP (universal falling) :
- Tested VERY precisely

# Gravitational Formfactors (Pagels'66, Ji'97)

$$\langle p' | T_{q,g}^{\mu\nu} | p \rangle = \bar{u}(p') \left[ A_{q,g}(\Delta^2) \gamma^{(\mu} p^{\nu)} + B_{q,g}(\Delta^2) P^{(\mu} i \sigma^{\nu)\alpha} \Delta_\alpha / 2M \right] u(p)$$

- Conservation laws - zero Anomalous Gravitomagnetic Moment :  $\mu_G = J$  (g=2)

$$P_{q,g} = A_{q,g}(0) \quad A_q(0) + A_g(0) = 1$$

$$J_{q,g} = \frac{1}{2} [A_{q,g}(0) + B_{q,g}(0)] \quad A_q(0) + B_q(0) + A_g(0) + B_g(0) = 1$$

- No  $M_{pl}$ ! May be extracted from high-energy experiments/NPQCD calculations
- Describe the partition of angular momentum between quarks and gluons **Ji's SRs**
- Describe interaction with both classical and TeV gravity

# Ji's and 1<sup>st</sup> moment "mass" SRs: Generalized Parton Distributions imply models for both EM and Gravitational Formfactors (Selyugin, OT '09)

- Smaller mass square radius (attraction vs repulsion ☺): follows from Regge behaviour of GPDs  $\sim \chi^{a(t)}$  (cf AdS QCD)

$$\rho(b) = \sum_q e_q \int dx q(x, b) = \int d^2q F_1(Q^2 = q^2) e^{i\vec{q}\vec{b}}$$

$$= \int_0^\infty \frac{q dq}{2\pi} J_0(qb) \frac{G_E(q^2) + \tau G_M(q^2)}{1 + \tau}$$

$$\rho_0^{\text{Gr}}(b) = \frac{1}{2\pi} \int_0^\infty dq q J_0(qb) A(q^2)$$

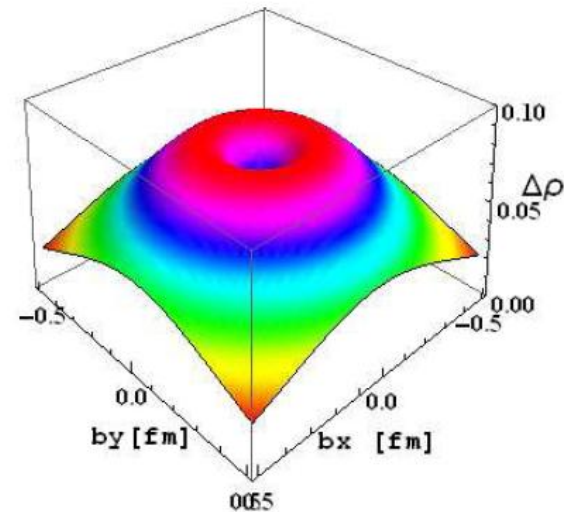

FIG. 17: Difference in the forms of charge density  $F_1^P$  and "matter" density ( $A$ )



# Gravitomagnetism

---

- Gravitomagnetic field (weak, except in gravity waves) – action on spin from  $M = \frac{1}{2} \sum_{q,G} \langle P' | T_{q,G}^{\mu\nu} | P \rangle h_{\mu\nu}(q)$

$$\vec{H}_J = \frac{1}{2} \text{rot} \vec{g}; \quad \vec{g}_i \equiv g_{0i}$$

spin dragging twice  
smaller than EM

- Lorentz force – similar to EM case: factor  $1/2$  cancelled with 2 from frequency same as EM

$$h_{00} = 2\phi(x) \quad \text{Larmor}$$

$$\omega_J = \frac{\mu_G}{J} H_J = \frac{H_L}{2} = \omega_L \quad \vec{H}_L = \text{rot} \vec{g}$$

- Orbital and Spin momenta dragging – the same - Equivalence principle





# Equivalence principle

---

- Newtonian – “Falling elevator” – well known and checked (also for elementary particles)
- Post-Newtonian – gravity action on (**quantum!**) SPIN – known since 1962 (Kobzarev and Okun’; ZhETF paper contains acknowledgment to Landau: probably his last contribution to theoretical physics before car accident); rederived from conservation laws - Kobzarev and V.I. Zakharov
- Anomalous gravitomagnetic (and electric-CP-odd) moment is ZERO or
- Classical and QUANTUM rotators behave in the SAME way



# Experimental test of PNEP

- Reinterpretation of the data on G(EDM) search

PHYSICAL REVIEW  
LETTERS

---

---

VOLUME 68

13 JANUARY 1992

NUMBER 2

---

---

**Search for a Coupling of the Earth's Gravitational Field to Nuclear Spins in Atomic Mercury**

B. J. Venema, P. K. Majumder, S. K. Lamoreaux, B. R. Heckel, and E. N. Fortson

*Physics Department, FM-15, University of Washington, Seattle, Washington 98195*

(Received 25 September 1991)

- If (CP-odd!)  $G_{EDM}=0 \rightarrow$  constraint for AGM (Silenko, OT'07) from Earth rotation – was considered as obvious (but it is just EP!) background
- New high precision EDM experiments: gravity is essential (NN Nikolaev, Vergeles, Silenko, ...)

$$\mathcal{H} = -g\mu_N \mathbf{B} \cdot \mathbf{S} - \zeta \hbar \boldsymbol{\omega} \cdot \mathbf{S}, \quad \zeta = 1 + \chi$$

$$|\chi(^{201}\text{Hg}) + 0.369\chi(^{199}\text{Hg})| < 0.042 \quad (95\% \text{C.L.})$$

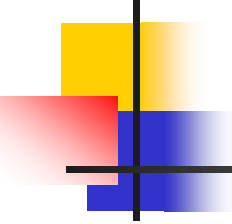

# EP and quantum measurement

---

- If spin is just a geometric vector, EP for Earth's rotation is "trivial": spin rotates with Earth's angular velocity like Foucault pendulum
- Non-trivial if **quantum measurement** (quite **practical** here) is performed in the rotating frame

# Equivalence principle for moving particles EP<sup>II</sup> vs EP<sup>I</sup>

- Compare gravity and acceleration: gravity provides EXTRA space components of metrics
- Matrix elements DIFFER  $h_{zz} = h_{xx} = h_{yy} = h_{00}$   
 $\mathcal{M}_g = (\epsilon^2 + p^2)h_{00}(q), \quad \mathcal{M}_a = \epsilon^2 h_{00}(q)$
- Ratio of accelerations:  $R = \frac{\epsilon^2 + p^2}{\epsilon^2}$  - confirmed by explicit solution of Dirac equation (Silenko, OT, '05)
- Arbitrary fields – Obukhov, Silenko, OT '09, '11, '13, 16, 17: also the same dynamics for classical and quantum rotators (“EP for strong fields”)

# Gravity vs accelerated frame for spin and helicity

- Spin precession – well known factor 3 (Probe B; spin at satellite – probe of PNEP!) – smallness of relativistic correction ( $\sim \mathbf{P}^2$ ) is compensated by  $1/\mathbf{P}^2$  in the momentum direction precession frequency
- Helicity flip – the same!
- No helicity flip in gravitomagnetic field – another formulation of PNEP (OT'99) and
- Flip by “gravitoelectric” field: relic neutrino (Anisotropic Universe: Kamenshchik, OT'15)?  
Black hole?

$$\frac{d\sigma_{+-}}{d\sigma_{++}} = \frac{tg^2(\frac{\phi}{2})}{(2\gamma - \gamma^{-1})^2}$$



# Gyromagnetic and Gravigyromagnetic ratios

---

- Free particles – coincide
- $\langle P+q | T^{mn} | P-q \rangle = P^{\{m} \langle P+q | J^{n\} \rangle | P-q \rangle / e$  up to the terms linear in  $q$
- Gravitomagnetic  $g=2$  for any spin
- Special role of  $g=2$  for ANY spin (asymptotic freedom for vector bosons)
  
- Should Einstein know about PNEP, the outcome of his and de Haas experiment would not be so surprising
- Recall also  $g=2$  for Black Holes. Indication of “quantum” nature?!

# Cosmological implications of PNEP

- Necessary condition for Mach's Principle (in the spirit of **S. Weinberg's** textbook-Section 9.7)
- Lense-Thirring inside massive rotating empty shell (=model of Universe)
- For **flat** "Universe" - precession frequency equal to that of shell rotation
- Simple observation-Must be the same for classical and **quantum** rotators – PNEP!
- More elaborate models - Tests for cosmology ?!

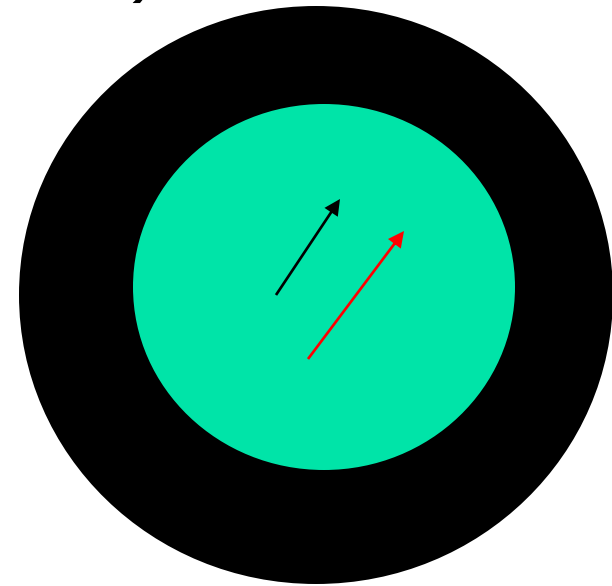

# Generalization of Equivalence principle

- Various arguments:  $AGM \approx 0$  separately for quarks and gluons – most clear from the lattice (LHPC/SESAM)

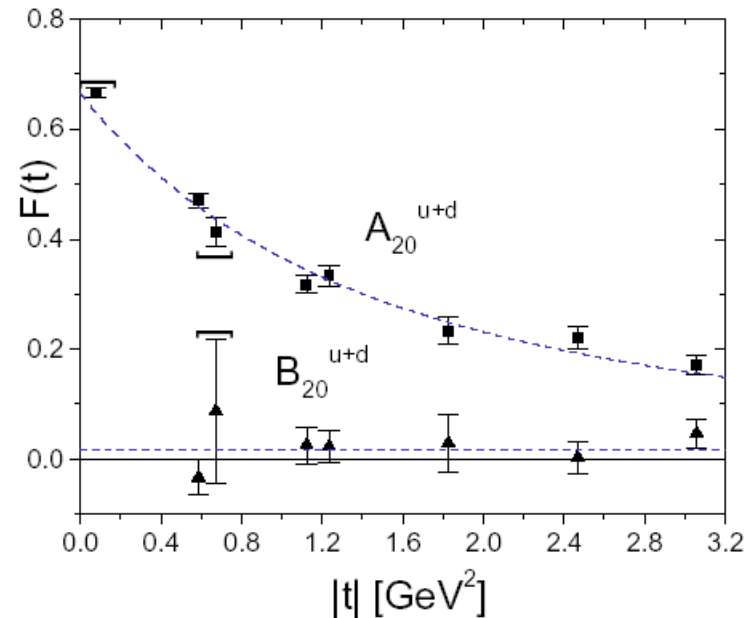
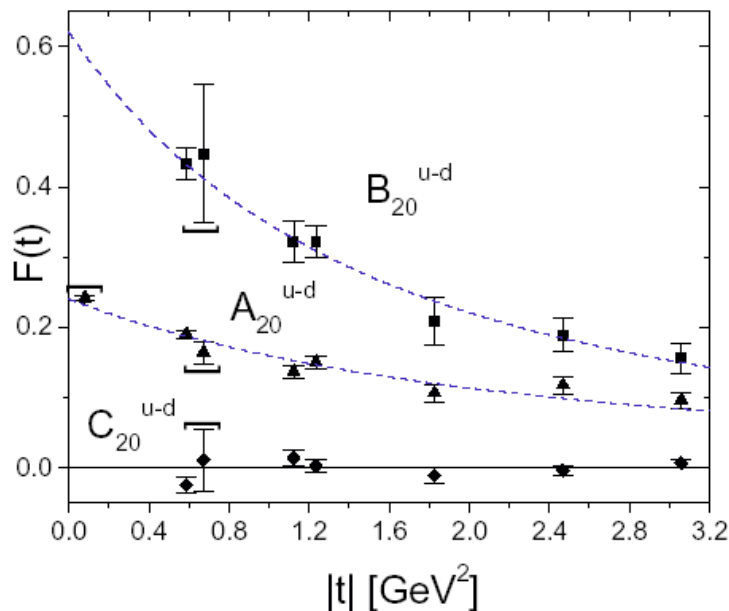



More recent lattice study (M. Deka,...K.-F. Liu et al. Phys.Rev. D91 (2015) no.1, 014505)

- Sum of u and d for Dirac (T1) and Pauli (T2) FFs

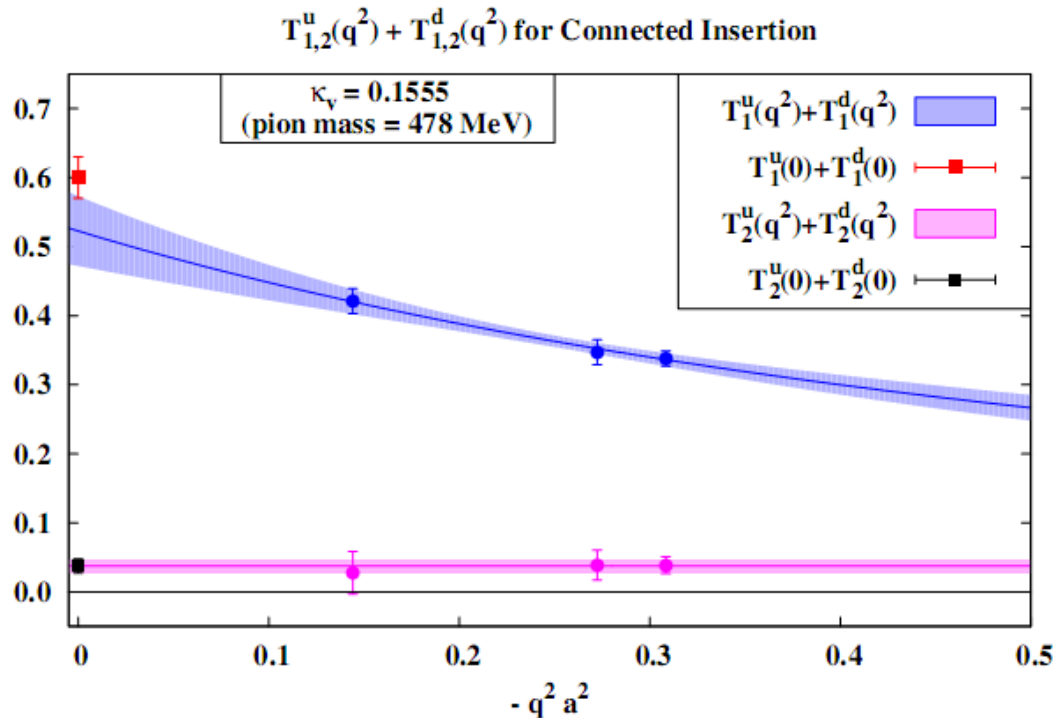

# Extended Equivalence

## Principle = Exact EquiPartition

- In NLO pQCD – violated (LF:S.Brodsky et al.)
- Reason – in the case of ExEP- no smooth transition for zero fermion mass limit (Milton, 71)
- Conjecture (O.T., 2001 – prior to lattice data) – valid in NP QCD – zero quark mass limit is safe due to chiral symmetry breaking
- Gravityproof confinement?! Nucleons do not break even by black holes?! Match BH complementarity?! “GeV Gravity”?
- Support by recent observation of smallness of EP-forbidden “Cosmological Constant”



# Exact Equipartition and Pivot

---

- Important notion introduced by C. Lorce to relate transverse spin SR's of Ji&Yuan and Leader et al.
- Naïve interpretation of ExEP: common (approximately, averagely) pivot for quarks and gluons:
  - $\langle J_{T(q,G)} \rangle = \langle X_0 \rangle \langle P_{L(q,G)} \rangle$
  - Can this be satisfied for some of pivot choices?

# Quadrupole formfactor: Inflation and annihilation

- Quadrupole gravitational FF

$$\langle P + q/2 | T^{\mu\nu} | P - q/2 \rangle = C(q^2)(g^{\mu\nu} q^2 - q^\mu q^\nu) + \dots$$

- Vacuum – Cosmological Constant

$$\langle 0 | T^{\mu\nu} | 0 \rangle = \Lambda g^{\mu\nu}$$

- **2D** effective CC – negative in scattering, positive in annihilation

$$\Lambda = C(q^2)q^2$$

- Similarity of inflation and Schwinger pair production – Starobinsky, Zel'dovich
- Was OUR Big Bang resulting from one graviton annihilation at extra dimensions??! Version of "ekpyrotic" ("pyrotechnic") universe
- Traceless+Trace =
- $M_I$ : (3/4+1/4) X.Ji'96
- $M_{Gr}$ : (3/2-1/2) OT'99 ("Antigravity": seen in trace part of Einstein Eqs)
- Access: D-term in GPDs

# Way to D-term: cf QCD Factorization for DIS and DVCS (AND VM production)

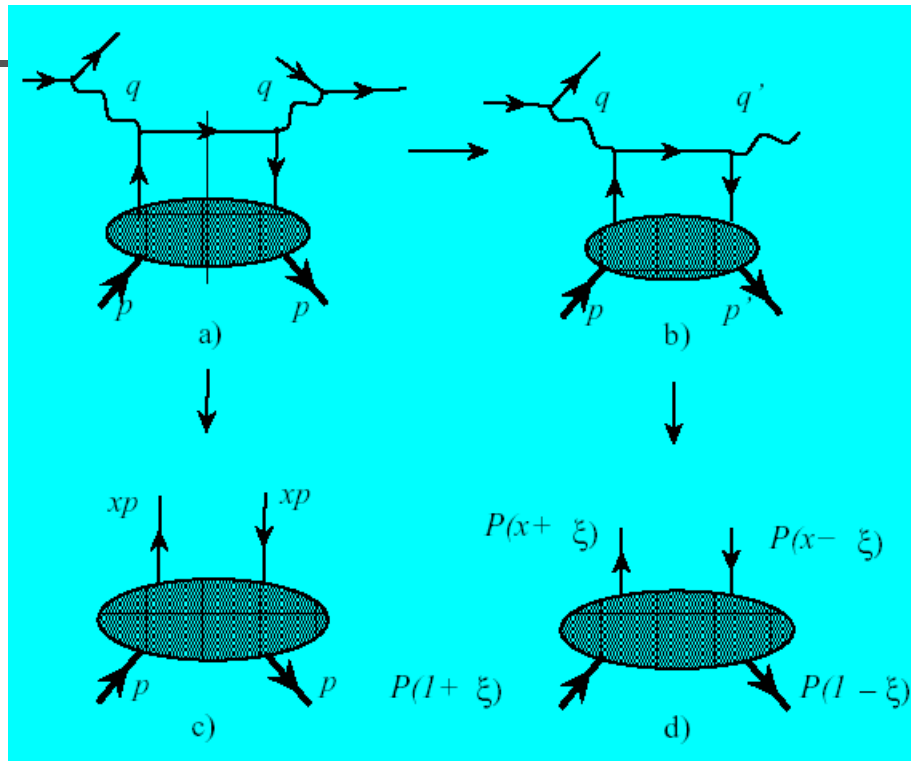

- Manifestly spectral

$$\mathcal{H}(x_B) = \int_{-1}^1 dx \frac{H(x)}{x - x_B + i\epsilon}$$

- Extra dependence on  $\xi$

$$\mathcal{H}(\xi) = \int_{-1}^1 dx \frac{H(x, \xi)}{x - \xi + i\epsilon}$$



# Unphysical regions

---

- DIS : Analytical function – polynomial in  $1/x_B$  if  $1 \leq |X_B|$

$$H(x_B) = -\int_{-1}^1 dx \sum_{n=0}^{\infty} H(x) \frac{x^n}{x_B^{n+1}}$$

- DVCS – additional problem of analytical continuation of  $H(x, \xi)$
- Solved by using of Double Distributions Radon transform

$$H(z, \xi) = \int_{-1}^1 dx \int_{|x|-1}^{1-|x|} dy (F(x, y) + \xi G(x, y)) \delta(z - x - \xi y)$$

# Double distributions and their integration

- Slope of the integration line-skewness
- Kinematics of DIS:  $\xi = 0$   
("forward") - vertical line (1)
- Kinematics of DVCS:  $\xi < 1$   
- line 2
- Line 3:  $\xi > 1$  unphysical region - required to restore DD by inverse Radon transform: tomography

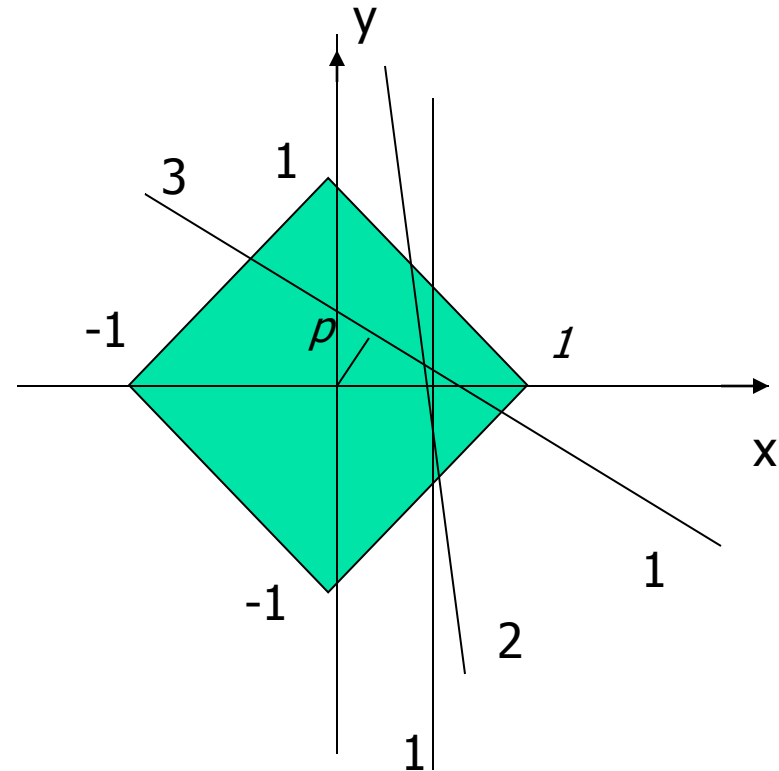

$$\begin{aligned}
 f(x, y) &= -\frac{1}{2\pi^2} \int_0^\infty \frac{dp}{p^2} \int_0^{2\pi} d\phi |\cos\phi| (H(p/\cos\phi + x + ytg\phi, t g\phi) - H(x + ytg\phi, t g\phi)) = \\
 &= -\frac{1}{2\pi^2} \int_{-\infty}^\infty \frac{dz}{z^2} \int_{-\infty}^\infty d\xi (H(z + x + y\xi, \xi) - H(x + y\xi, \xi))
 \end{aligned}$$

# Crossing for DVCS and GPD

- DVCS  $\rightarrow$  hadron pair production in the collisions of real and virtual photons
- GPD  $\rightarrow$  Generalized Distribution Amplitudes
- Duality between s and t channels  
(Polyakov, Shuvaev, Guzey, Vanderhaeghen)

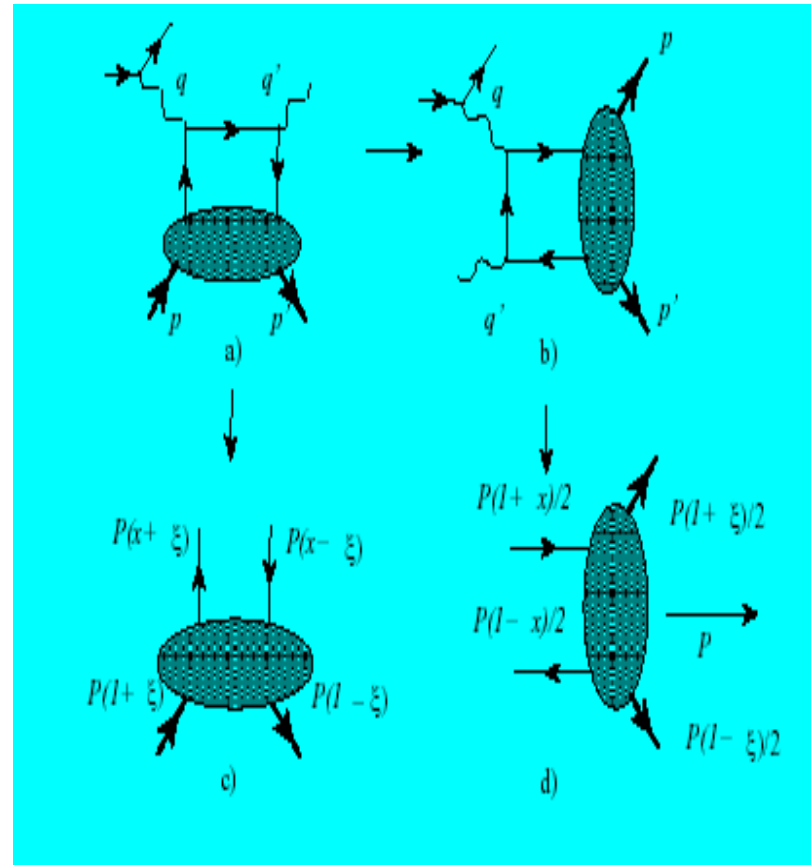



# GDA -> back to unphysical regions for DIS and DVCS

- Recall DIS

$$H(x_B) = - \int_{-1}^1 dx \sum_{n=0}^{\infty} H(x) \frac{x^n}{x_B^{n+1}}$$

- Non-positive powers of  $x_B$

- DVCS

$$H(\xi) = - \int_{-1}^1 dx \sum_{n=0}^{\infty} H(x, \xi) \frac{x^n}{\xi^{n+1}}$$

- Polynomiality (general property of Radon transforms): moments - integrals in  $x$  weighted with  $x^n$  - are polynomials in  $1/\xi$  of power  $n+1$
- As a result, analyticity is preserved: only non-positive powers of  $\xi$  appear



# Holographic property (OT'05)

Factorization  
Formula

->

- Analyticity ->  
Imaginary part ->  
Dispersion relation:

$$\mathcal{H}(\xi) = \int_{-1}^1 dx \frac{H(x, \xi)}{x - \xi + i\epsilon}$$

$$\mathcal{H}(\xi) = \int_{-1}^1 dx \frac{H(x, x)}{x - \xi + i\epsilon}$$

$$\Delta\mathcal{H}(\xi) \equiv \int_{-1}^1 dx \frac{H(x, x) - H(x, \xi)}{x - \xi + i\epsilon}$$

- “Holographic”  
equation (DVCS **AND**  
**VM**)

$$= \sum_{n=1}^{\infty} \frac{1}{n!} \frac{\partial^n}{\partial \xi^n} \int_{-1}^1 H(x, \xi) dx (x - \xi)^{n-1} = \text{const}$$



# Holographic property - II

---

- Directly follows from double distributions

$$H(z, \xi) = \int_{-1}^1 dx \int_{|x|-1}^{1-|x|} dy (F(x, y) + \xi G(x, y)) \delta(z - x - \xi y)$$

- Constant is the SUBTRACTION one - due to the (generalized) Polyakov-Weiss term  $G(x, y)$

$$\Delta \mathcal{H}(\xi) = \int_{-1}^1 dx \int_{|x|-1}^{1-|x|} dy \frac{G(x, y)}{1 - y}$$

$$= - \left( \int_{-\xi}^{\xi} dx \frac{D(x/\xi)}{x - \xi + i\epsilon} = \int_{-1}^1 dz \frac{D(z)}{z - 1} = \text{const} \right)$$

# Holographic property - III

- 2-dimensional space  $\rightarrow$  1-dimensional section!
- Momentum space: any relation to holography in coordinate space ?!
- Strategy (now adopted) of GPD's studies: start at diagonals  
(through SSA due to imaginary part of DVCS amplitude ) and restore by making use of dispersion relations + subtraction constants

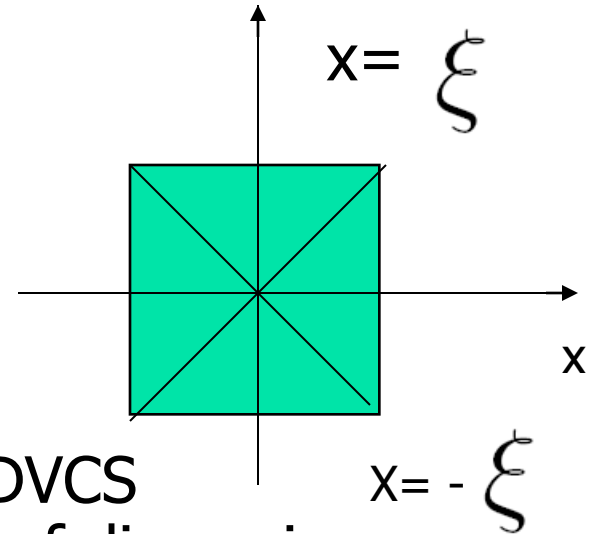

# Analyticity of Compton amplitudes in energy plane (Anikin, OT'07)

- Finite subtraction implied

$$\operatorname{Re}\mathcal{A}(\nu, Q^2) = \frac{\nu^2}{\pi} \mathcal{P} \int_{\nu_0}^{\infty} \frac{d\nu'^2}{\nu'^2} \frac{\operatorname{Im}\mathcal{A}(\nu', Q^2)}{(\nu'^2 - \nu^2)} + \Delta \quad \Delta = 2 \int_{-1}^1 d\beta \frac{D(\beta)}{\beta - 1}$$

$$\Delta_{\text{CQM}}^p(2) = \Delta_{\text{CQM}}^n(2) \approx 4.4, \quad \Delta_{\text{latt}}^p \approx \Delta_{\text{latt}}^n \approx 1.1$$

- Numerically close to Thomson term for real proton (but NOT neutron) Compton Scattering!
- Duality (sum of squares vs square of sum; proton:  $4/9+4/9+1/9=1$ )?!



# *From D-term to pressure*

---

- *Inverse -> 1<sup>st</sup> moment (model)*
- *Kinematical factor: weighted pressure*  
 $C \sim \langle p r^A \rangle$  ( $\langle p r^2 \rangle = 0$ ) *M. Polyakov'03*

$$T_{\mu\nu}^Q(\vec{r}, \vec{s}) = \frac{1}{2E} \int \frac{d^3\Delta}{(2\pi)^3} e^{i\vec{r}\cdot\vec{\Delta}} \langle p', S' | \hat{T}_{\mu\nu}^Q(0) | p, S \rangle$$

$$T_{ij}(\vec{r}) = s(r) \left( \frac{r_i r_j}{r^2} - \frac{1}{3} \delta_{ij} \right) + p(r) \delta_{ij}$$

- *Justification: (Fourier inversed)  
consistency principle for Born  
gravitational scattering? 2D <-> 3D?*

# The pressure distribution inside the proton

V. D. Burkert<sup>1\*</sup>, L. Elouadrhiri<sup>1</sup> & F. X. Girod<sup>1</sup>

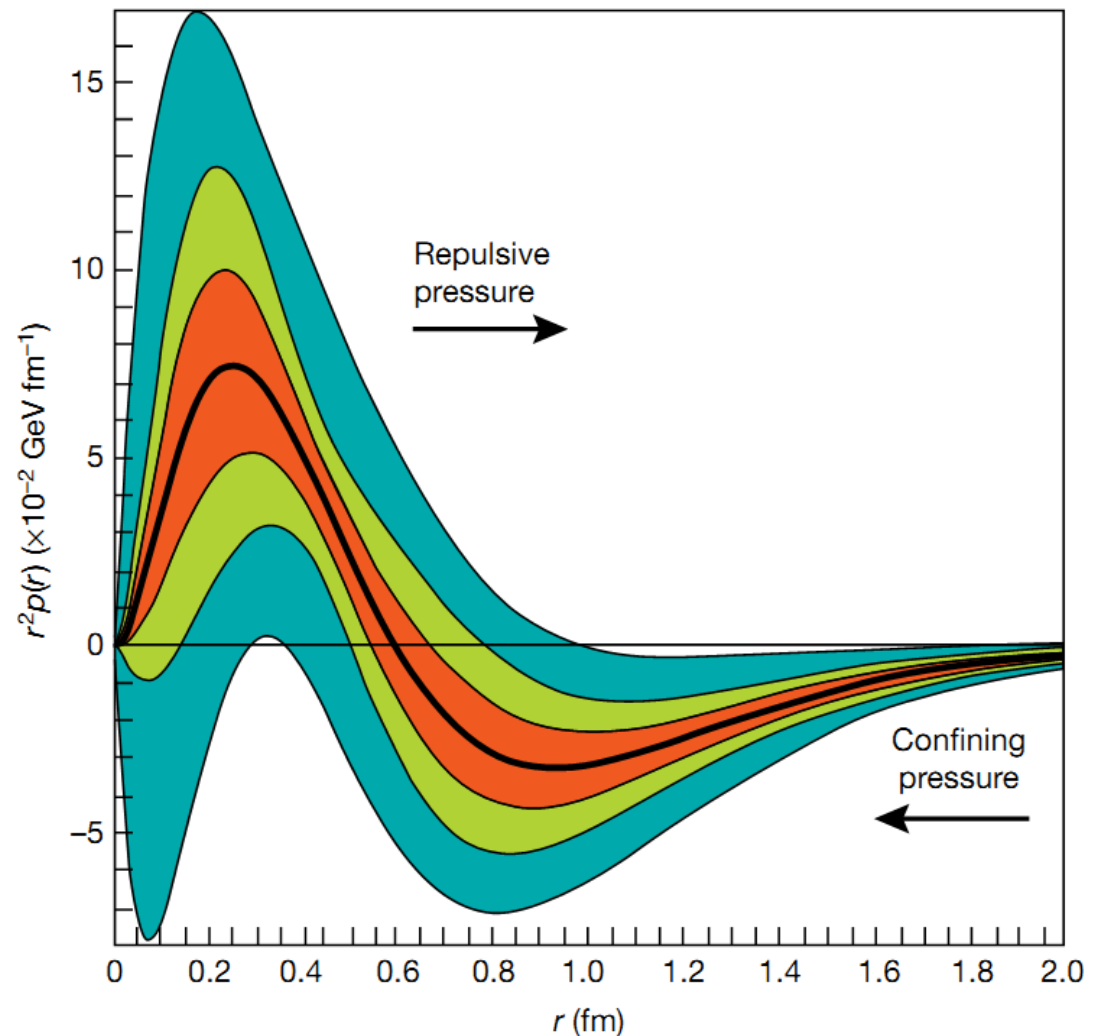

# Gravitational formfactors and pressure in hadron pairs production

- Back to GDA region
- -> moments of  $H(x,x)$  - define the coefficients of powers of cosine! -  $1/\xi$
- Higher powers of cosine in t-channel – threshold in s-channel
- Larger for pion than for nucleon pairs because of less fast decrease at  $x \rightarrow 1$
- Stability defines the sign of GDA

$$\begin{aligned} \mathcal{H}(\xi) &= - \int_{-1/\xi}^{1/\xi} dx \sum_{n=0}^{\infty} H(x, \xi) \frac{x^n}{\xi^{n+1}} \\ &= - \int_{-1/\xi}^{1/\xi} dx \sum_{n=0}^{\infty} H(x, x) \frac{x^n}{\xi^{n+1}} + \Delta \mathcal{H}. \end{aligned}$$



# Quantum roots of classical stability

- GPDs

$$\Delta\mathcal{H}(\xi) \equiv \int_{-1}^1 dx \frac{H(x, x) - H(x, \xi)}{x - \xi + i\epsilon}$$

- $= - \left( \int_{-\xi}^{\xi} dx \frac{D(x/\xi)}{x - \xi + i\epsilon} = \int_{-1}^1 dz \frac{D(z)}{z - 1} = \text{const} \right)$

- Sufficient condition: positive (because of forward limit!)  $H$  is a decreasing function of  $x$  at any  $\xi$

- GDA's  $H(z, \xi) = \text{sign}(\xi) \Phi\left(\frac{z}{\xi}, \frac{1}{\xi}\right)$

$$\begin{aligned} \mathcal{H}(\xi) &= - \int_{-1/\xi}^{1/\xi} dx \sum_{n=0}^{\infty} H(x, \xi) \frac{x^n}{\xi^{n+1}} \\ &= - \int_{-1/\xi}^{1/\xi} dx \sum_{n=0}^{\infty} H(x, x) \frac{x^n}{\xi^{n+1}} + \Delta\mathcal{H}. \end{aligned}$$

- Positivity of GDA balance between unitarity and stability
- Soft PION theorem – positivity of DA!?

# Gravitational FFs from Belle data on GDAs

S. Kumano, Qin-Tao Song and O. Teryaev, PRD 97 (2018) 014020.

- Gravitational FFs are related to twist-2 GDAs

GDAs

$$A_{\lambda_1 \lambda_2} = T_{\mu\nu} \varepsilon^\mu(\lambda_1) \varepsilon^\nu(\lambda_2) / e^2$$

$$A_{++} = \sum_q \frac{e_q^2}{2} \int_0^1 dz \frac{2z-1}{z(1-z)} \Phi^q(z, \xi, W^2)$$

$$\int dz (2z-1) \Phi_q^+(z, \xi, W^2) = \frac{2}{(P^+)^2} \langle \pi^+(p_1) \pi^-(p_2) | T_q^{++}(0) | 0 \rangle$$

$$\langle \pi^0(p_1) \pi^0(p_2) | T^{\mu\nu}(0) | 0 \rangle = \frac{1}{2} \left[ (sg^{\mu\nu} - P^\mu P^\nu) \Theta_1 + \Delta^\mu \Delta^\nu \Theta_2 \right]$$

$$P = p_1 + p_2, \Delta = p_1 - p_2$$

M. Masuda et al. [Belle Collaboration], PRD 93 (2016), 032003

- Belle data and scaling :  $W = 0.525, 0.975, 1.55$  GeV

$$\frac{(Q^2 + s) d\sigma}{\beta d|\cos\theta|} \propto \left| \Phi^{s^*s^*}(z, \cos\theta, W, Q) \right|^2$$

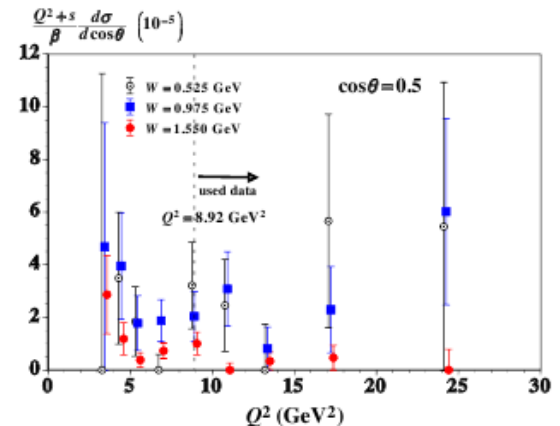
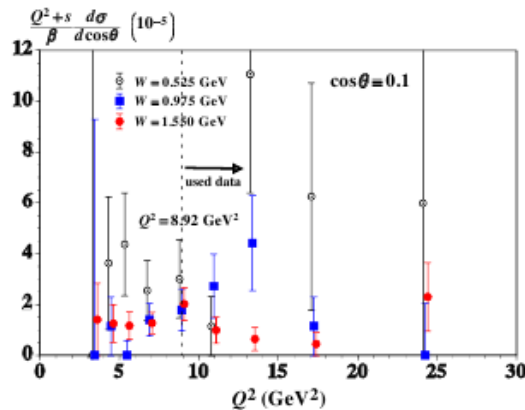

# Phase shifts and resonances

- Leading harmonics

$$\begin{aligned}\sum_q \Phi_q^+(z, \xi, W^2) &= 18n_f z(1-z)(2z-1)[B_{10}(W) + B_{12}(W)P_2(2\xi-1)] \\ &= 18n_f z(1-z)(2z-1)[\tilde{B}_{10}(W) + \tilde{B}_{12}(W)P_2(\cos\theta)]\end{aligned}$$

$$\tilde{B}_{10}(W) = \bar{B}_{10}(W)e^{i\delta_0}, \tilde{B}_{12}(W) = \bar{B}_{12}(W)e^{i\delta_2}$$

- S/D shifts

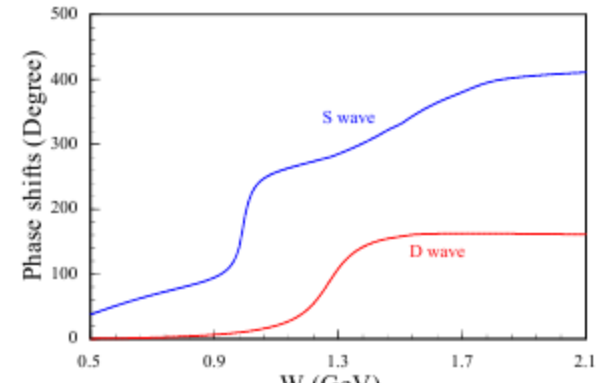

- $f_0(500)$ ,  $f_2(1270)$  contributions

$$\begin{aligned}\bar{B}_{12}(W) &= \beta^2 \frac{10g_{f_2\pi\pi}f_{f_2}M_{f_2}^2}{9\sqrt{2}\sqrt{(M_{f_2}^2 - W^2)^2 - \Gamma_{f_2}^2 M_{f_2}^2}} \\ \bar{B}_{10}(W) &= \frac{5g_{f_0\pi\pi}f_{f_0}}{3\sqrt{2}\sqrt{(M_{f_0}^2 - W^2)^2 - \Gamma_{f_0}^2 M_{f_0}^2}}\end{aligned}$$

# Fits and results

- Collection

$$\Phi_q^+(z, \xi, W^2) = N_h z^\alpha (1-z)^\alpha (2z-1) [\tilde{B}_{10}(W) + \tilde{B}_{12}(W) P_2(\cos \theta)]$$

$$\tilde{B}_{10}(W) = \left[ \frac{-3 + \beta^2}{2} \frac{5R_\pi}{9} F_h(W^2) + \frac{5g_{f_0\pi\pi} f_{f_0}}{3\sqrt{2} \sqrt{(M_{f_0}^2 - W^2)^2 - \Gamma_{f_0}^2 M_{f_0}^2}} \right] e^{i\delta_0}$$

$$\tilde{B}_{12}(W) = \left[ \beta^2 \frac{5R_\pi}{9} F_h(W^2) + \beta^2 \frac{10g_{f_2\pi\pi} f_{f_2} M_{f_2}^2}{9\sqrt{2} \sqrt{(M_{f_2}^2 - W^2)^2 - \Gamma_{f_2}^2 M_{f_2}^2}} \right] e^{i\delta_2}$$

$$F_h(W^2) = \frac{1}{\left[ 1 + \frac{W^2 - 4m_\pi^2}{\Lambda^2} \right]^{n-1}}$$

- Best fit with (2) and without (1)  $f_0$

	Set 1	Set 2
$\alpha$	0.801±0.042	1.157± 0.132
$\Lambda$	1.602±0.109	1.928±0.213
a	3.878± 0.165	3.800± 0.170
b	0.382± 0.040	0.407± 0.041
$f_{f_0}$	-----	0.0184± 0.034

$$\frac{\chi^2}{NOF} = 1.22$$

$$\frac{\chi^2}{NOF} = 1.09$$

# Description of data

$d\sigma/d\cos\theta$  (nb)

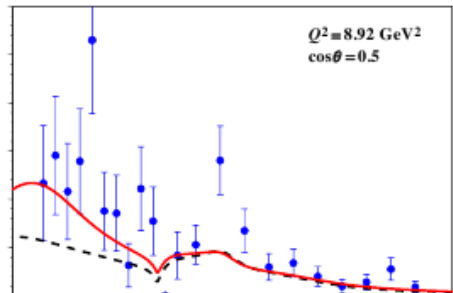
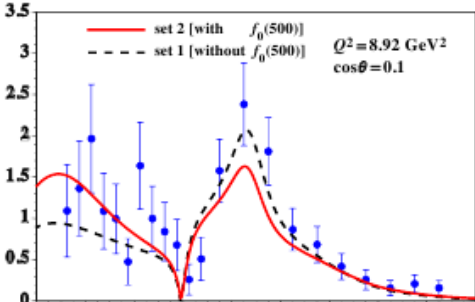

$d\sigma/d\cos\theta$  (nb)

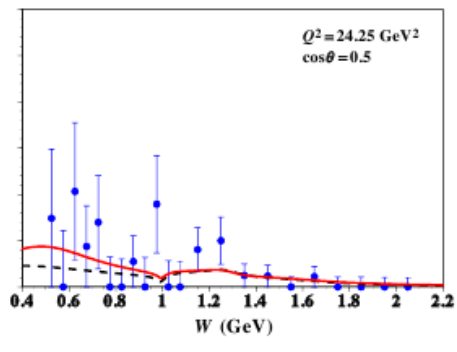
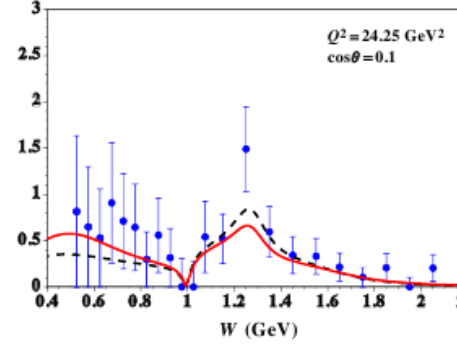
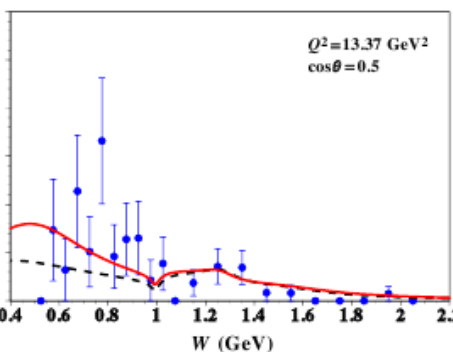
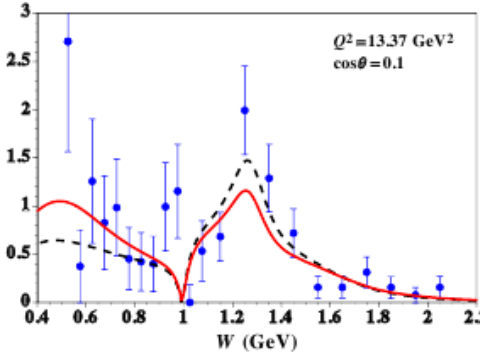
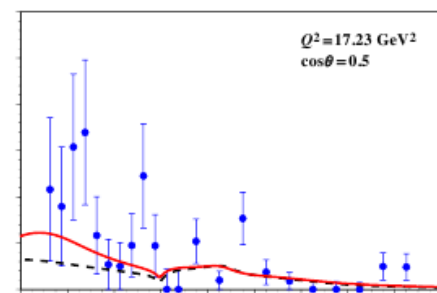
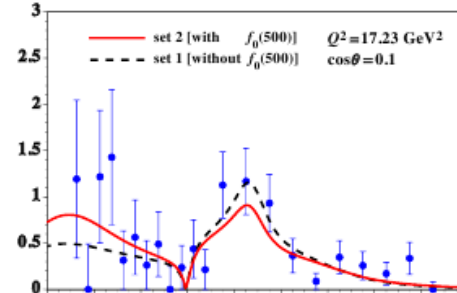

# Formfactors

- Resonance structure in pressure – related  $\Theta_1$

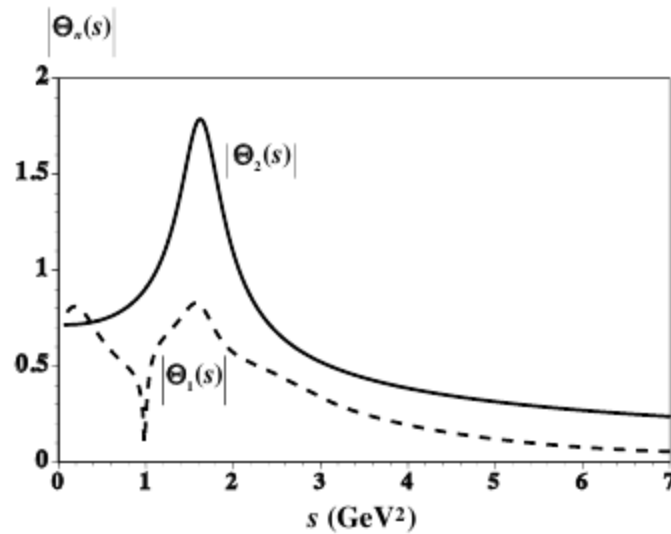

# Time-like $\rightarrow$ space-like

- Dispersion relation and Fourier transform

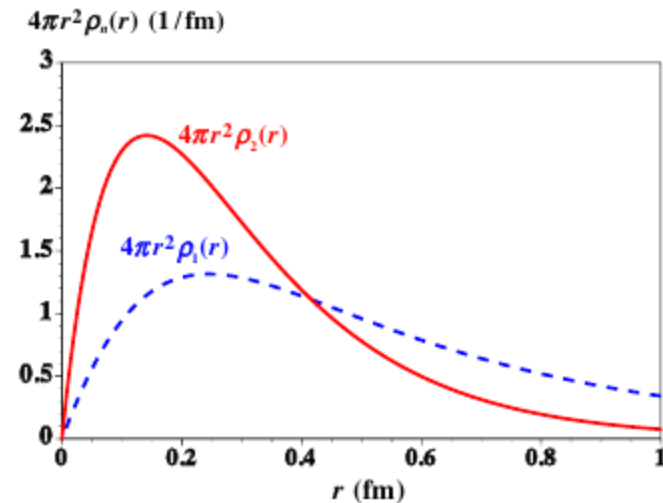
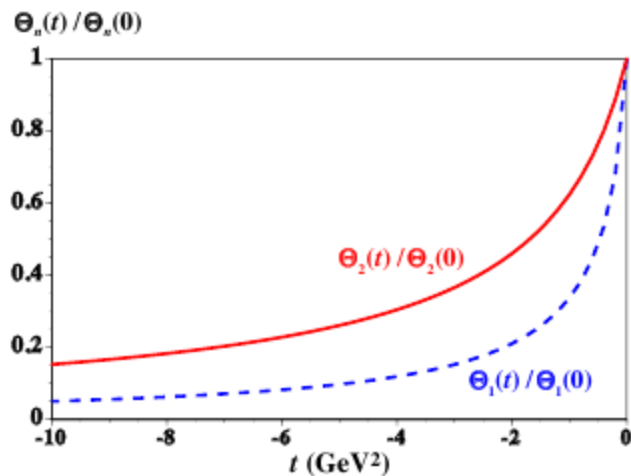

- Mass radius

$$\langle r^2 \rangle = 6 \int \frac{\text{Im}(F(s))}{s^2} ds$$

$$\sqrt{\langle r^2 \rangle} = 0.69 \text{ fm for } \Theta_2$$



# Spin 1 EMT and **inclusive** processes

---

- Forward matrix element  $\rightarrow$  density matrix
- Contains **P-even** term: tensor polarization  $S^{\alpha\beta}$
- Symmetric and **traceless**: correspond to (average) **shear** forces
- For spin  $1/2$ : **P-odd** vector polarization requires another vector ( $q$ ) to form vector product





# SUM RULEs

---

- Efremov, OT'81 : zero sum rules:
- Current conservation: 1<sup>st</sup> moment: also in parton model by Close and Kumano (90)
- EMT conservation: 2<sup>nd</sup> moment (forward analog of Ji's SR:  $AGM = \langle A_T \rangle = 0$ )
- Average shear force (compensated between quarks and gluons)
- Gravity and (Ex)EP (zero average shear separately for quarks and gluons) – OT'09

# Manifestation of post-Newtonian (Ex)EP for spin 1 hadrons

- Tensor polarization - coupling of EMT to spin in forward matrix elements - inclusive processes
- Second moments of tensor distributions should sum to zero

$$A_T = \frac{\sigma_+ + \sigma_- - 2\sigma_0}{3\bar{\sigma}}$$

$$\int_0^1 C_i^T(x) dx = 0$$

$$\langle P, S | \bar{\psi}(0) \gamma^\nu D^{\nu_1} \dots D^{\nu_n} \psi(0) | P, S \rangle_{\mu^2} = i^{-n} M^2 S^{\nu\nu_1} P^{\nu_2} \dots P^{\nu_n} \int_0^1 C_q^T(x) x^n dx \quad (\text{AVE.OT'91.93})$$

$$\sum_q \langle P, S | T_i^{\mu\nu} | P, S \rangle_{\mu^2} = 2P^\mu P^\nu (1 - \delta(\mu^2)) + 2M^2 S^{\mu\nu} \delta_1(\mu^2)$$

$$\langle P, S | T_g^{\mu\nu} | P, S \rangle_{\mu^2} = 2P^\mu P^\nu \delta(\mu^2) - 2M^2 S^{\mu\nu} \delta_1(\mu^2)$$

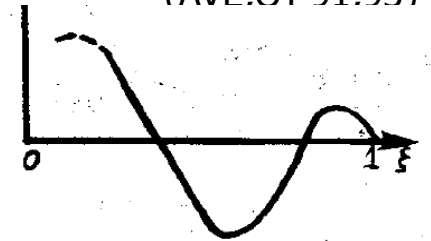

$$\sum_q \int_0^1 C_i^T(x) x dx = \delta_1(\mu^2) = 0 \quad \text{for ExEP}$$

# HERMES – data on tensor spin structure function

PRL 95, 242001 (2005)

- Isoscalar target – proportional to the sum of u and d quarks – combination required by (Ex)EP
- Second moments – compatible to zero better than the first one (collective tensor polarized glue  $\ll$  sea)

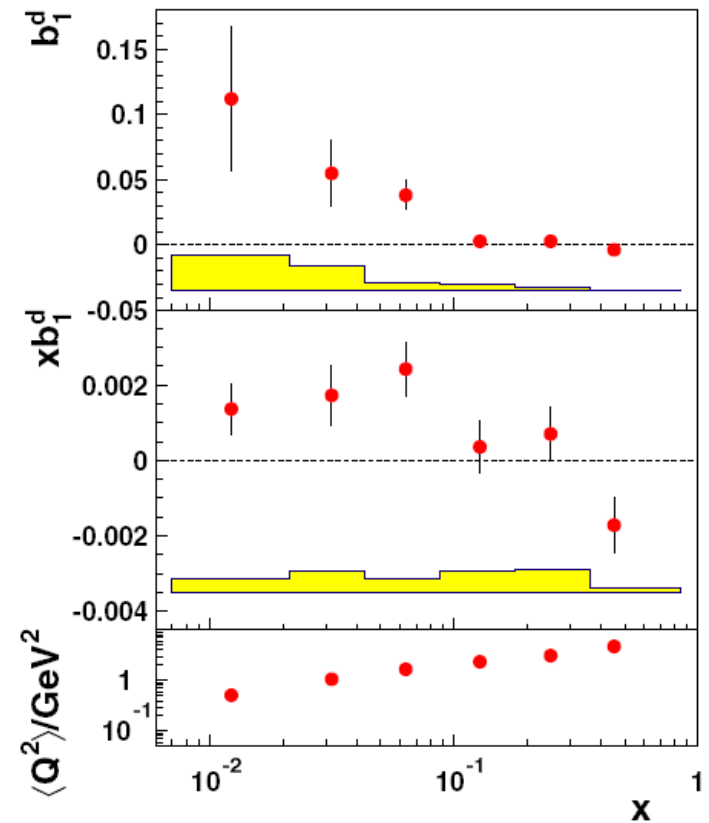



# Where else to test?

---

- **EIC**
- DY@J-PARC
- ET'81-**any** hard process (“multi-messenger”)
- Possibility: **hadronic** tensor SSA@**NICA**

# Fragmentation functions

- Tensor polarized fragmentation functions: (Szymanowski, Schaefer, OT'99)

*A. Schäfer et al. / Physics Letters B 464 (1999) 94–100*

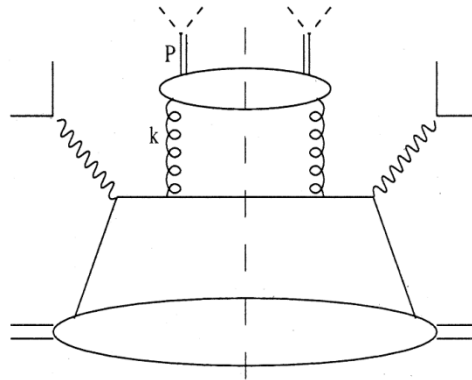

- **Suggestion'21**: zero SRs (analogous to momentum SR) may probe the (Ex)EP for hadrons inside partons (EIC: gluons)

# More on vector mesons and ExEP

- $J=1/2 \rightarrow J=1$ . QCD SR/model/lattice calculation of Rho's AMM gives  $g$  close to 2 ( $g=2$  exactly in AdS QCD).
- Why?
- Maybe because of similarity of moments and ExEP
- $g-2 = \langle E_u(x) \rangle$ ;  $B = \langle x E_u(x) \rangle$
- Directly for charged Rho (combinations like  $p+n$  for nucleons unnecessary!). Not reduced to non-extended EP: Gluons momentum fraction sizable

# EP: Where is the fastest possible rotation and acceleration?

- Non-central heavy ion collisions (Angular velocity  $\sim c/\text{Compton wavelength}$ )  $\Omega \sim \frac{c}{\lambda_p} = \frac{m_p c^2}{\hbar}$
- $\sim 25$  orders of magnitude faster than Earth's rotation  $\eta_{\text{rot}} = \frac{\Omega}{\omega_{\oplus}} = \frac{c}{R_A} \cdot \frac{T_{\oplus}}{2\pi} = \frac{1}{2\pi} \cdot \frac{cT_{\oplus}}{R_A} \approx 10^{27}$
- Differential rotation – vorticity
- P-odd : May lead to various P-odd effects (Chiral magnetic/vortical effects)
- Acceleration: even larger ratio with the gravity of Earth

$$\eta_{\text{acc}} = \frac{c}{R_A} \cdot \frac{c}{g_{\oplus}} = \eta_{\text{rot}} \frac{2\pi c}{T_{\oplus} g_{\oplus}} \approx 10^{30} \qquad \eta_{\text{acc}} = \frac{c}{R_A} \cdot \frac{c}{g_{\oplus}} = \frac{c^2}{v_{\oplus}^2} \cdot \frac{R_{\oplus}}{R_A}$$

# Effective field theory: Anomalies

- 4-Velocity is also a **GAUGE FIELD** (V.I. Zakharov et al)

$$e_j A_\alpha J^\alpha \Rightarrow \mu_j V_\alpha J^\alpha$$

- Triangle anomaly leads to polarization of quarks and hyperons (Rogachevsky, Sorin, OT '10)
- Analogous to anomalous gluon contribution to nucleon spin (Efremov, OT'88)
- 4-velocity instead of gluon field potential and vorticity -----//----- (chromo)magnetic field strength!

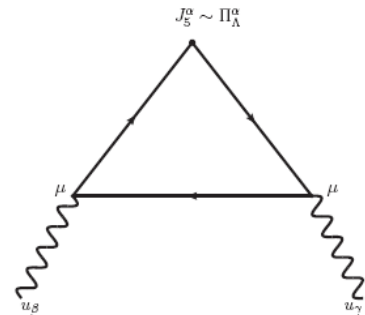



# Observable for AVE: polarization

**O. Rogachevsky, A. Sorin, O. Teryaev**  
**Chiral vortical effect and neutron asymmetries in**  
**heavy-ion collisions**  
**PHYSICAL REVIEW C 82, 054910 (2010)**

One would expect that polarization is proportional to the anomalously induced axial current [7]

$$j_A^\mu \sim \mu^2 \left( 1 - \frac{2\mu n}{3(\epsilon + P)} \right) \epsilon^{\mu\nu\lambda\rho} V_\nu \partial_\lambda V_\rho, \quad (6)$$

where  $n$  and  $\epsilon$  are the corresponding charge and energy densities and  $P$  is the pressure. Therefore, the  $\mu$  dependence of polarization must be stronger than that of the CVE, leading to the effect's increasing rapidly with decreasing energy.

This option may be explored in the framework of the program of polarization studies at the NICA [17] performed at collision points as well as within the low-energy scan program at the RHIC.

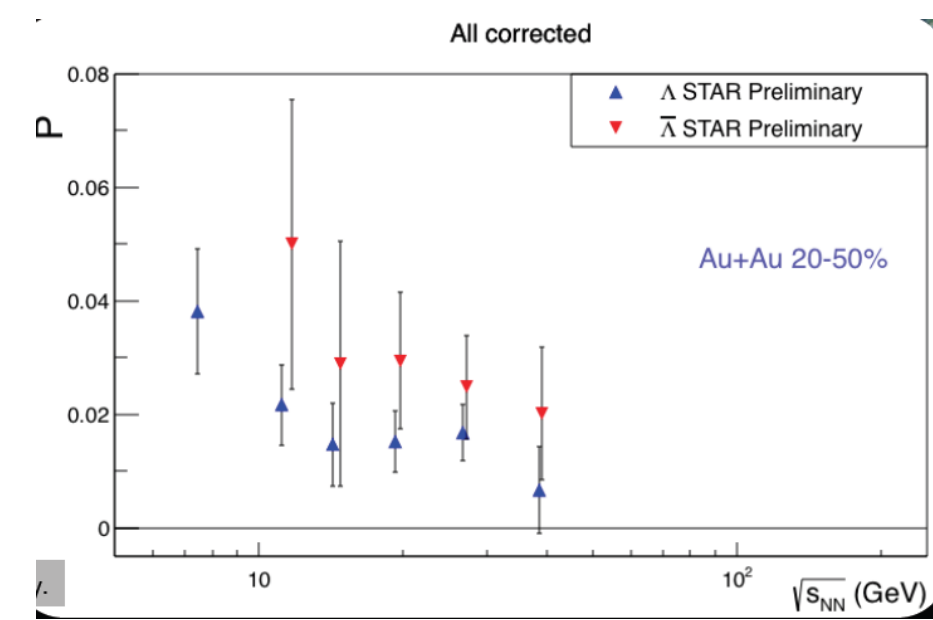
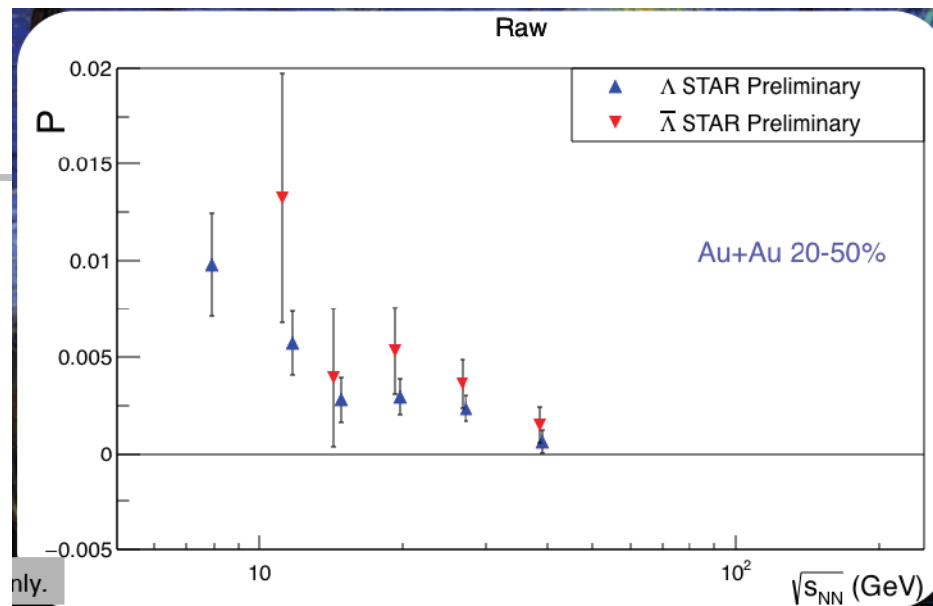

# NICA (Nuclotron based Ion Collider Facility)

– the flagship project in HEP  
of Joint Institute for Nuclear Research (JINR)

Main targets of “NICA Complex”:

- study of hot and dense baryonic matter
- investigation of hadronic spin structure through various polarization phenomena
- development of accelerator facility for HEP @ JINR providing intensive beams of relativistic ions from  $p$  to  $Au$

polarized protons and deuterons  
with energy up to  
 $\sqrt{s}_{NN} = 11 \text{ GeV}$  ( $Au^{79+}$ ,  $L \sim 10^{32} \text{ cm}^{-2} \text{ c}^{-1}$ )  
 $\sqrt{s} = 27 \text{ GeV}$  ( $p$ ,  $L \sim 10^{32} \text{ cm}^{-2} \text{ c}^{-1}$ )

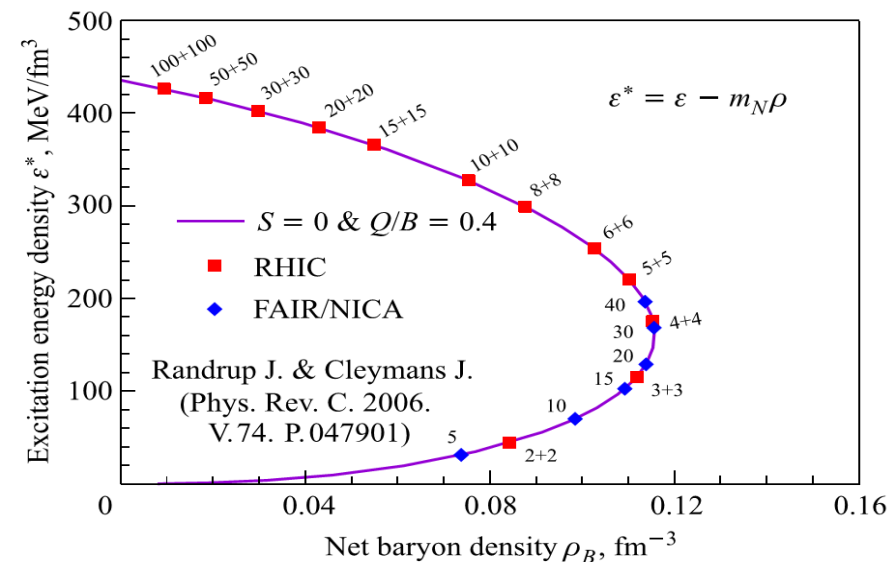

# NICA: heavy ions and hadrons

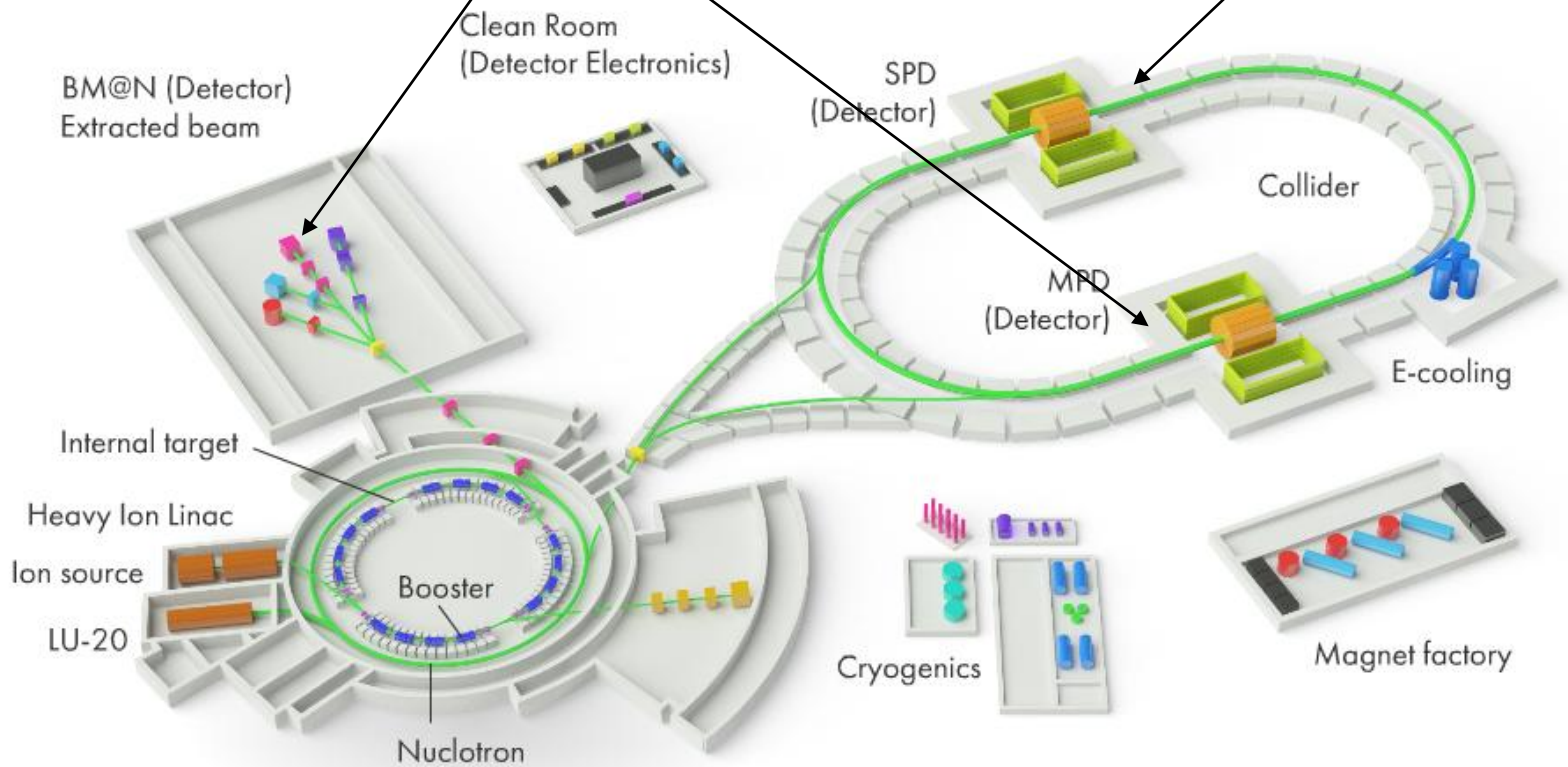



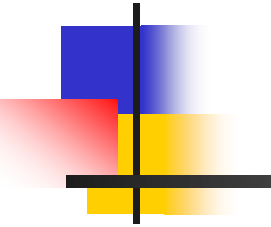



# Why EP and rotating frame?

---

- Statistical approach (F. Becattini et al.; “Standard Model” for polarization): spin equilibrium in rotating frame
- Decrease with energy: explained by decrease of (relevant) hydrodynamic vorticity (Betz, Torrieri, Csernai, Becattini, Karpenko, Lisa,...)
- **Interesting to compare with quantum measurement essential for EP**: Landau&Lifshitz v. 5, Section 8 (“Law of entropy increasing”): possible relation of inequivalence of time directions due to quantum measurements
- **EP/quantum measurement/statistics interplay** (recall history of Kobzarev&Okun publication)?!
- Cf.: EP violation (modification?) due to thermal effects (non-zero AGM: Buzzegoli, Kharzeev’21)

# Comparison of approaches: Axial (“anomalous” without anomaly) current in TD approach: Vilenkin’82,..

- Prokhorov, Zakharov, OT’18: Threshold effects in chemical potential and **angular velocity**
- **From equilibrated spin of massive hadrons to EFT for spin of massless quarks**

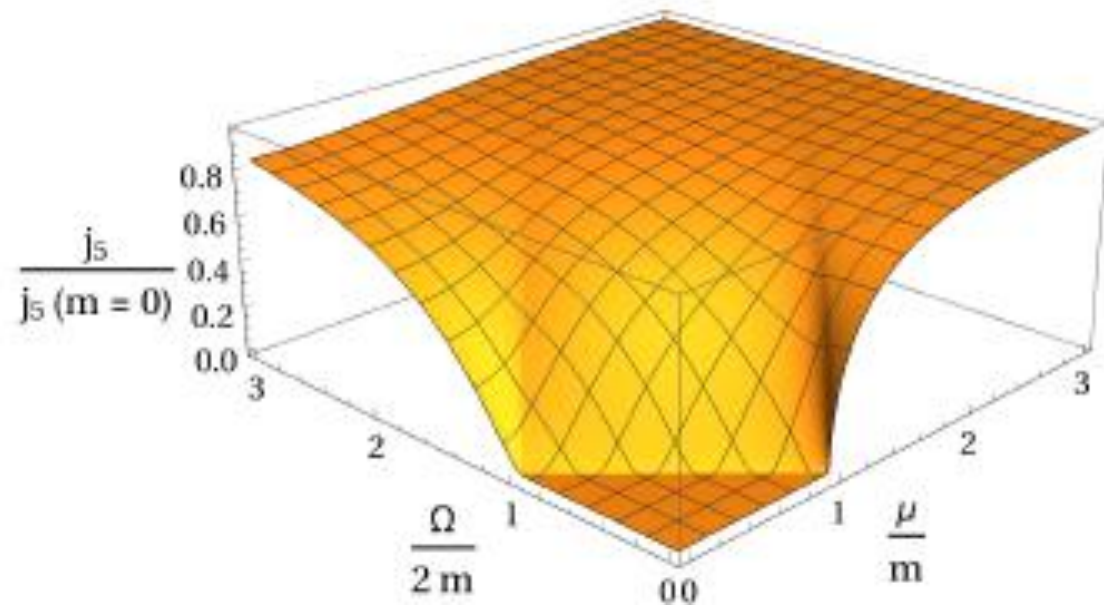

# Rotated and accelerated frame: Wigner function and Zubarev density operator

- G. Prokhorov, V. Zakharov, OT '19:
- Imaginary chemical potential due to acceleration appears!

$$\langle J_{\mu}^5 \rangle = \frac{\omega_{\mu} + i \operatorname{sgn}(\omega a) a_{\mu}}{2(g_u - i g_a)} \int \frac{d^3 p}{(2\pi)^3} \times \{ n_F(E_p - \mu - g_u/2 + i g_a/2) - n_F(E_p - \mu + g_u/2 + i g_a/2) + n_F(E_p + \mu - g_u/2 + i g_a/2) - n_F(E_p + \mu + g_u/2 - i g_a/2) \} + \text{c.c.},$$

$$\rho = \frac{7\pi^2 T^4}{60} + \frac{T^2 a^2}{24} - \frac{17a^4}{960\pi^2} = 2 \int \frac{d^3 p}{(2\pi)^3} \left( \frac{|\mathbf{p}| + ia}{1 + e^{\frac{|\mathbf{p}|}{T} + \frac{ia}{2T}}} + \frac{|\mathbf{p}| - ia}{1 + e^{\frac{|\mathbf{p}|}{T} - \frac{ia}{2T}}} \right) + 4 \int \frac{d^3 p}{(2\pi)^3} \frac{|\mathbf{p}|}{e^{\frac{2\pi|\mathbf{p}|}{a}} - 1} \quad (T > T_U) \quad \text{in red: modifications compared to the Wigner function}$$

- In the first integral, the **acceleration** enters as an **imaginary chemical potential**  $\pm \frac{ia}{2}$  [G.P., O. Teryaev, V. Zakharov, Phys. Rev. D 98, no. 7, 071901 (2018)].



# Statistics vs geometry: Unruh effect (Becattini'18; Prokhorov, OT, Zakharov'19)

- Results for energy density of thermal system in **Minkowski** space coincide with the early known for the space with conical singularity (e.g. cosmic strings)

$$c_V = \frac{\mu_s^2 + \mu_A^2}{2\pi^2} + \frac{T^2}{6}, \quad Q_5^s = N_c \int d^3x c_V \gamma^2 \epsilon^{ijk} v_i \partial_j v_k$$

$$\rho_{s=0} = \frac{\pi^2 T^4}{30} + \frac{T^2 |a|^2}{12} - \frac{11 |a|^4}{480 \pi^2},$$

$$\rho_{s=1/2} = \frac{7\pi^2 T^4}{60} + \frac{T^2 |a|^2}{24} - \frac{17 |a|^4}{960 \pi^2}$$

- Energy density turns to zero for  $T=T_U=a/(2\pi)$  (~"physical conditions of renormalization". also simple explanation of coefficient)

# Instability for high accelerations

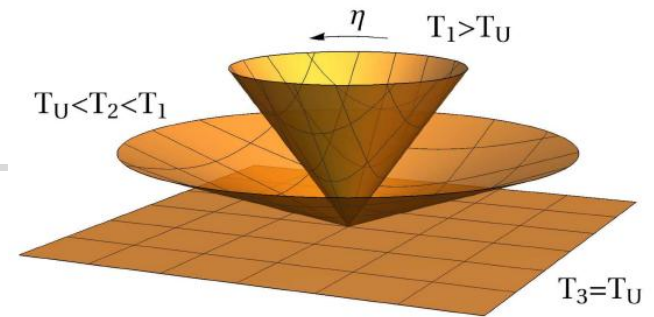

- Normally  $T > T_U$
- Fast acceleration without thermalization: instability

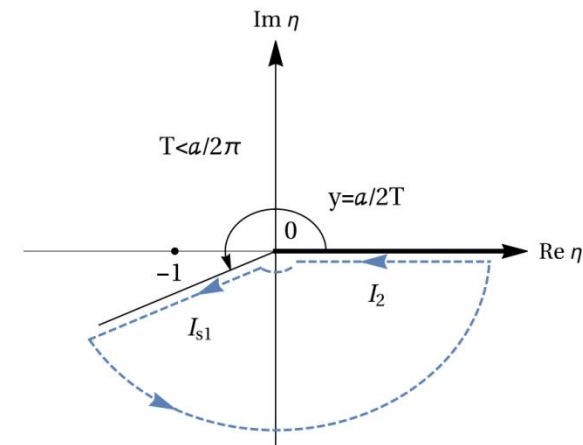
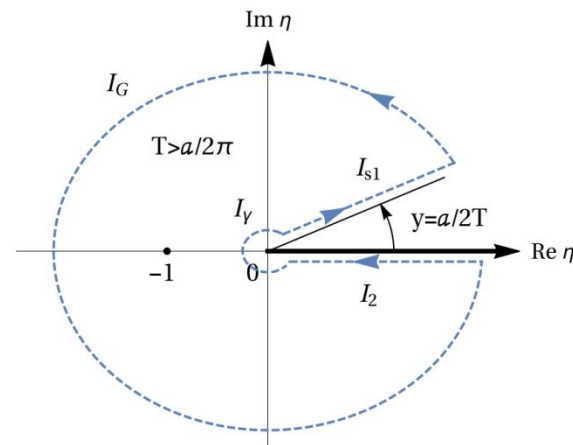

- EP  $\sim$  fall to BH?
- Censorship: Origin for fast thermalization?



# CONCLUSIONS

---

- Equivalence principle: allows to study interplay of QCD and gravity
- Modern accelerators (LHC, RHIC, CEBAF EIC, FAIR, NICA... also “effective gravity” labs



# Conclusions/Outlook

---

- EMT coupling
- Separate couplings of quarks and gluons to gravity: ExEP, pressure, shear, cosmological constant
- EP in QCD matter (“GeV gravity”)
- Anomalous transport and polarization
- Unruh radiation



# OUTLOOK

---

- EP-I/EPII intersections
- Pressure, shear, EoS for hadrons
- Helicity flip (Relic neutrino, PTOLEMY, Dark matter)



# BACKUP

---



# Is D-term independent?

- Fast enough decrease at large energy -

$$> \quad \text{Re } \mathcal{A}(\nu) = \frac{\mathcal{P}}{\pi} \int_{\nu_0}^{\infty} d\nu'^2 \frac{\text{Im } \mathcal{A}(\nu')}{\nu'^2 - \nu^2} + \mathbf{C}_0.$$

$$\begin{aligned} \mathbf{C}_0 &= \Delta - \frac{\mathcal{P}}{\pi} \int_{\nu_0}^{\infty} d\nu'^2 \frac{\text{Im } \mathcal{A}(\nu')}{\nu'^2} \\ &= \Delta + \mathcal{P} \int_{-1}^1 dx \frac{H^{(+)}(x, x)}{x}. \end{aligned}$$

- FORWARD limit of Holographic equation

$$\begin{aligned} \Delta &= \mathcal{P} \int_{-1}^1 dx \frac{H^{(+)}(x, 0) - H^{(+)}(x, x)}{x} & \mathbf{C}_0(t) &= 2\mathcal{P} \int_{-1}^1 dx \frac{H(x, 0, t)}{x} \\ &= 2\mathcal{P} \int_{-1}^1 dx \frac{H(x, 0) - H(x, x)}{x}, \end{aligned}$$



# “D – term” 30 years before...

---

- Cf Brodsky, Close, Gunion'72 (**seagull**  $\sim$  **pressure**) – but NOT DVMP
- D-term – a sort of renormalization constant
- May be calculated in effective theory if we know fundamental one
- OR
- Recover through special regularization procedure (D. Mueller)?





# ExEP and AdS/QCD

---

- Recent development – calculation of Rho formfactors in Holographic QCD (Grigoryan, Radyushkin)
- Provides  $g=2$  identically!
- Experimental test at time –like region possible



# ExEP and Sivers function

---

- Sivers function – process dependent (effective) one
- T-odd effect in T-conserving theory- phase
- FSI – Brodsky-Hwang-Schmidt model
- Unsuppressed by M/Q twist 3
- Process dependence- colour factors
- After Extraction of phase – relation to universal (T-even) matrix elements



# ExEP and Sivers function -II

---

- Qualitatively similar to OAM and Anomalous Magnetic Moment (talk of S. Brodsky)
- Quantification : weighted TM moment of Sivers PROPORTIONAL to GPD E (OT'07, **hep-ph/0612205** ) :  $x f_T(x) : xE(x)$
- Burkardt SR for Sivers functions is then related to Ji's SR for E and, in turn, to Equivalence Principle

$$\sum_{q,G} \int dx x f_T(x) = \sum_{q,G} \int dx x E(x) = 0$$



# ExEP and Sivers function for deuteron

---

- EEP - smallness of deuteron Sivers function
- Cancellation of Sivers functions – separately for quarks (before inclusion gluons)
- Equipartition + small gluon spin – large longitudinal orbital momenta (BUT small transverse ones –Brodsky, Gardner)

# Another relation of Gravitational FF and NP QCD (first reported at 1992: **hep-ph/9303228** )

- BELINFANTE (relocalization) invariance :

decreasing in coordinate –

$$M^{\mu,\nu\rho} = \frac{1}{2} \epsilon^{\mu\nu\rho\sigma} J_{S\sigma}^5 + x^\nu T^{\mu\rho} - x^\rho T^{\mu\nu}$$

smoothness in momentum space

$$M^{\mu,\nu\rho} = x^\nu T_B^{\mu\rho} - x^\rho T_B^{\mu\nu}$$

- Leads to absence of massless pole in singlet channel – U<sub>A</sub>(1)

$$\epsilon_{\mu\nu\rho\alpha} M^{\mu,\nu\rho} = 0.$$

- Delicate effect of NP QCD

$$(g_{\rho\nu} g_{\alpha\mu} - g_{\rho\mu} g_{\alpha\nu}) \partial^\rho (J_{5S}^\alpha x^\nu) = 0$$

- Equipartition – deeply related to relocalization invariance by QCD evolution

$$q^2 \frac{\partial}{\partial q^\alpha} \langle P | J_{5S}^\alpha | P + q \rangle = (q^\beta \frac{\partial}{\partial q^\beta} - 1) q_\gamma \langle P | J_{5S}^\gamma | P + q \rangle$$

$$\langle P, S | J_\mu^5(0) | P + q, S \rangle = 2MS_\mu G_1 + q_\mu (Sq) G_2, \\ q^2 G_2|_0 = 0$$



# Holography vs NLO

---

- Depends on factorization scheme
- Special role of scheme preserving the coefficient function
- Nucleon as (scheme dependent) black hole – 3D information encoded in 2D



## C vs Cbar ( $=\Lambda$ )

---

- Cancellations of Cbars – negative pressure
- Cf Chaplygin gas: ( $p=-A/\rho$ ) – analog of cosmological constant
- Cancellation in vacuum; Pauli (divergent), Zel'dovich (finite)
- Flavour structure of pressure: DVMP!